

# ZAXIS200



## HYDRAULIC EXCAVATOR

Model Code : ZX200-5G / ZX200LC-5G / ZX210H-5G / ZX210LCH-5G  
ZX210K-5G / ZX210LCK-5G

Engine Rated Power : 125 kW (168 HP)

Operating Weight : ZX200-5G : 19 800 kg / ZX200LC-5G : 20 400 kg  
ZX210H-5G : 21 100 kg / ZX210LCH-5G : 21 500 kg  
ZX210K-5G : 21 100 kg / ZX210LCK-5G : 21 500 kg

Backhoe Bucket : ISO Heaped : 0.51 - 1.20 m<sup>3</sup>

# ZAXIS Empower your Vision.

A ZAXIS hallmark – industry-leading hydraulic technologies, and performance no other can beat. New ZAXIS provides reliable solutions: impressive fuel economy, swift front movements, and easy operation. You'll also find Hitachi technological prowess and expertise, such as the optimized hydraulic system and engine.

New ZAXIS features the key benefits of high quality, low fuel consumption, and high durability, all of which serve to ensure low running costs.

New ZAXIS, which is empowered by comprehensive evolution, will realize customers' visions and dreams, and pioneer your colorful future.

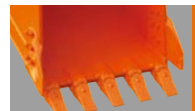

## More Production with Less Fuel

Page 4-5

- 9% reduction in fuel consumption
- More fuel reduction in the ECO mode
- Swift front movements with HIOS III hydraulics
- Powerful lifting operation
- Boosted swing torque
- Enhanced power boost



## No Compromise on Operator Comfort

Page 8-9

- Comfortable operating environment
- Comfort-designed operator seat
- Robust cab
- New, easy-to-use multifunctional monitor



## Reliable Solutions, with Various Options

Page 12-13

- Varied jobs, varied options
- Recommended options



## Various Versions

Page 16-17

- Heavy-duty version: H-series
- Demolition version: K-series



## Pursuits of Performance and Durability

Page 6-7

- Prestige R&D and quality control
- Durable, reliable engine
- Rock-solid, durable front attachment
- Strengthened undercarriage
- Proven upperstructure



## Simplified Maintenance

Page 10-11

- Dust-proof indoor net
- Grouped remote inspection points
- Attractive, robust body
- Low life cycle costs



## Hitachi Support Chain

Page 14-15

- Remote fleet management with Global e-Service
- Parts and service



Note: The photos in this brochure show excavators with optional equipments such as rear view camera.

## More Production with Less Fuel

### 9% Reduction in Fuel Consumption

New ZAXIS is a fuel-thrifty excavator that can reduce fuel consumption by 9%\*, compared to the conventional ZX200-3/ZX200-3F family, thanks to the HIOS III hydraulic system and engine control system, thereby reducing CO<sub>2</sub> emissions.

\*5%, compared to the ZX200/ZX200-3G.

### More Fuel Reduction in the ECO mode

The ECO mode, a new economical mode, can further cut fuel consumption by 9% compared to the PWR mode, without sacrificing digging speed by optimal matching of operations.



### Swift Front Movements with HIOS\* III Hydraulics

Operating speed increases with less fuel consumption thanks to the HIOS III hydraulic system, developed by industry-leading hydraulic technologies and a wealth of experience. Actuators work quickly by boom weight, without needing a regenerative circuit and pressure oil.

\*Human & Intelligent Operation System

### Rapid Arm Roll-in

Arm roll-in speed increases by combined flow from arm and boom cylinders through regenerative valves for productive excavation.

### Fast Arm Speed During Boom Lowering

Arm speed increases by boom weight during boom lowering, without needing pressure oil from a pump. That is, arm circuit flow is increased for higher arm speed, allowing for quick loading of a dump truck and positioning of the front.

### Powerful Lifting Operation

The Auto Power Lift mode, which automatically surge lifting force by 10% when needed, allows for powerful lifting of buried concrete pipes or sheathing sheets.

### Boosted Swing Torque

Allows for powerful wall cutting with the bucket, and smooth swing operation on slope.

### Enhanced Power Boost

The Power Boost mode allows the operator to surge 10% more digging force for powerful excavation by pressing its button on the control lever.



# Pursuits of Performance and Durability

## Prestige R&D and Quality Control

Hitachi has earned praise for technological prowess and product performance around the world. R&D Division has a track record – including excellent design, stress analysis expertise using CAE system, and abundant production data base. What's more, a large-scale durability test field (427 hm<sup>2</sup>) allows for a series of stringent testing of new machines.

Production Division strives to automatize production processes, including robotic welding, machining, painting, assembling and transferring.



Computer-Aided Engineering

Main pump testing area

Mid-sized excavator assembly line

Main frame welding line

Simulation testing from operator seat



## Durable, Reliable Engine

This engine has a track record showing impressive durability at countless tough job sites around the world.

The engine — associated with a rugged design, a direct fuel injection system and an elaborate governor — goes green, and complies with EU Stage II and US EPA Tier 2 emissions regulations.

The cooling system well keeps the engine cool. The engine cover has a wider air suction area, and radiators are arranged in parallel for efficient cooling. This parallel arrangement also facilitates their cleaning.

The ample-capacity intercooler and turbocharger help yield a whopping 125 kW (168 HP) output for higher production in shorter job schedule.

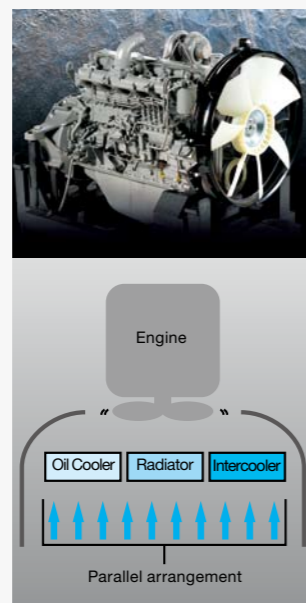

Engine

Oil Cooler Radiator Intercooler

Parallel arrangement

## Rock-Solid, Durable Front Attachment

The boom top and foot are reinforced with thickened high-tensile steel brackets, which incorporate steel bushings to enhance durability. Arm cylinder and boom cylinders (rod extend ends) cushion shocks at stroke ends to cut noise and extend service life.

Joint pins at the front attachment are tightly fit to reduce jolt and sound. The arm-bucket joint is protected by WC thermal spraying on its contact surfaces to reduce wear and jolt. New-type HN bushings, utilized on joint pins, retain grease inside for longer greasing intervals. A reinforced resin thrust plate, mounted on the bucket pin, helps reduce wearing noise.

## Strengthened Undercarriage

The X-beam frame is made monolithically with fewer welds for higher rigidity and durability. Track adjusters absorb impacts to crawlers. Front idlers and adjuster cylinders are integrated to increase durability. Idler brackets and travel motor brackets are both thickened for added durability.

## Proven Upperstructure

The upperstructure frame is reinforced with the proven D-section skirt to increase rigidity against damage by obstacles. A large door catch is added to reduce shocks and jolts of the cab and upperstructure.



HN bushing

Reinforced resin thrust plates

WC thermal spraying

X-beam frame

Track adjuster

Boom foot

# No Compromise on Operator Comfort

## Comfortable Operating Environment

You'll feel comfortable and confident, with plenty of leg space and excellent visibility when operating the cab. The new compact console gives more leg space. The new door pillar is shifted rearward by 70 mm to widen an entry space for easy access. A new LED room light, interlocked with the door, turns on when the door opens. The front window is easily removed and stored overhead using slide rails. The overhead window is openable for ventilation. Ample air conditioner vents are located strategically for uniform air circulation inside the cab. The control panel and control levers are arranged within easy reach of the operator. AM/FM radio and AUX port (optional) for a mobile music player are available for a long work day with less fatigue. All these designs focus on operator comfort.

## Comfort-Designed Operator Seat

The luxury cloth seat is fitted with a headrest and arm rests for operator comfort. The seat can be adjusted in multiple ways, sliding and reclining, to suit operator's size and preferences. The seat can slide rearward by 40 mm more for added leg space. An air suspension with a heat pad is optional.

## Robust Cab

The robust cab, meeting the OPG (Top Guard Level 1), protects the operator from falling objects. The pilot control shut-off lever is provided with a neutral engine start system that permits engine starting only when the pilot control shut-off lever is in Lock position.



Control panel

Large storage space



## New, Easy-to-Use Multifunction Monitor

The new multi-language, multifunction monitoring system comprises a 7-inch high-resolution color monitor and a multifunction controller. The monitor allows the operator to check varying operating variables: hydraulic oil temperature, fuel level, work mode, full-auto air conditioner, AM/FM radio, rear view monitor camera (optional), maintenance support, and attachment flow adjustment. Menu items can be selected and adjusted by a multifunction controller on the control panel. A new rear view monitor camera always displays the view behind the machine.



# Simplified Maintenance



The photo shows an excavator with an optional front glass lower guard.



## Dust-Proof Indoor Net

A dust-proof indoor net, provided at the front of radiator, can be easily removed and cleaned with compressed air. At the rear of the radiator, air blowing can be done through a one-touch open cover. The air condenser is openable for easy cleaning at its rear.

## Attractive, Robust Body

Side frame tops of the undercarriage are sloped to let muck slide away. Track adjuster greasing ports are repositioned for easier lubrication, and well protected from muck packing.

## Grouped Remote Inspection Points

Service points are concentrated inside left and right covers that are readily accessible from ground level for convenient servicing and inspection, including water draining from the fuel tank, replenishment of coolant, and replacement of filters. The fuel tank is anti-corrosion coated on its inside, and has a large cleaning port at the bottom. These wise designs effectively keep fuel clean, and ease servicing. Handrails are provided at convenient locations for easy riding on the upperstructure. Plenty slip-resistant plates are located for safe maintenance.

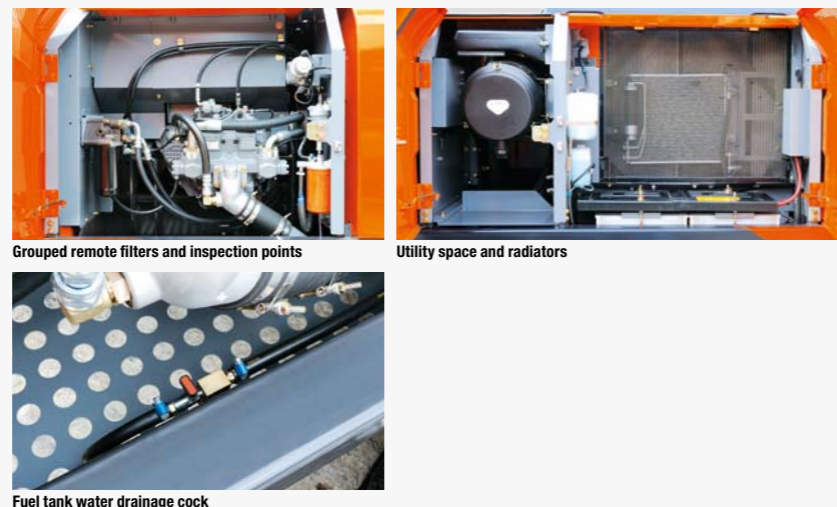

## Low Life Cycle Costs

Service intervals are long enough to slash maintenance costs.

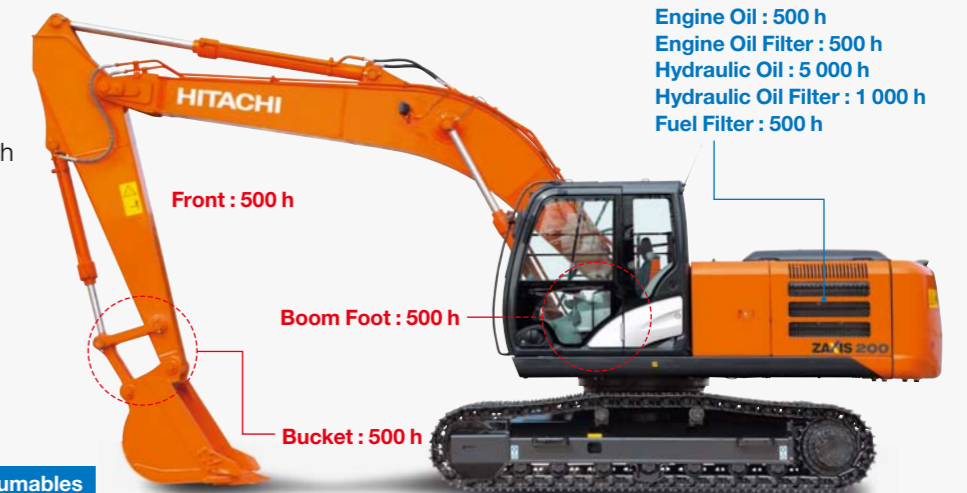

Note: Periodic inspection is required to check oil contamination and such.

# Reliable Solutions, with Various Options

## Easy-to-Use Attachments

The operator can change over valves, adjust extra circuit flow, and check settings from the multifunctional monitor next to the operator seat. What's more, 11 jobs, including flow rate setting, can easily be selected by their identified names.

## Easy-to-Operate Breaker

When using a breaker that requires frequent change of hydraulic oil and filters, an extra hour meter on the multifunctional monitor displays operating hours of the breaker, suggesting adequate replacement timing of oil and filters. The Breaker Alarm (optional) displays an alert mark on the monitor screen, and sounds when the breaker works continuously over one minute.

## Varied Jobs, Varied Options

Lower cab front guard is provided for protection against debris during demolition and breaker operation. High-performance filters and in-line filters are available at tough job sites.

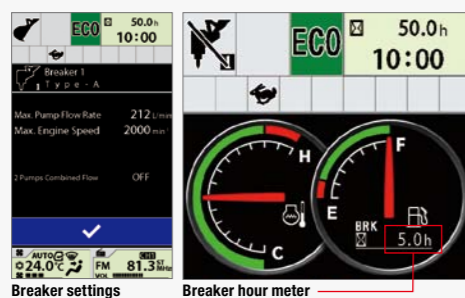

## Recommended Options



Attachment basic piping

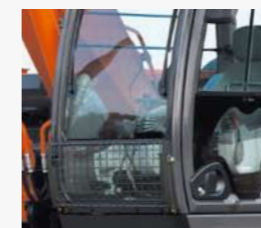

Lower cab front guard



Electric fuel refilling pump

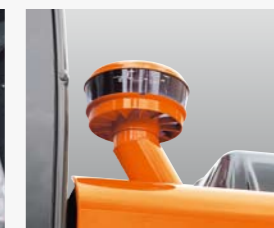

Pre-Cleaner

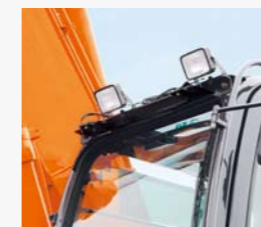

Additional cab roof front lights



Rear view camera

# Hitachi Support Chain

Hitachi Support Chain is a full customer support system offered after buying a Hitachi machine.

## Remote Fleet Management with Global e-Service

### Easy Access to On-Site Machines through the Internet

This on-line fleet management system allows you to access each on-site machine from a PC in your office. You can get its operating information and location to increase productivity of the fleet and reduce downtime. Operating data and log are sent to a Hitachi server for processing, and then to customer and dealers around the world. This system is available 24 hours a day, all the year around.

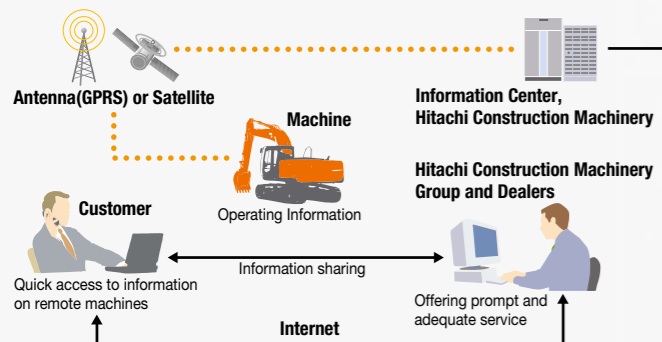

Note: In Some Regions, Global e-Service Is Not Available by Local Regulations.

### Main Features of Global e-Service

#### Functions

Global e-Service provides easy access to a machine on site, conveying operating information and log, including daily operating hours, fuel level, temperatures, pressures, and likes.

#### Maintenance

Maintenance data and log are displayed on a easy-to-read monitor screen, suggesting recommended maintenance for efficient fleet management.

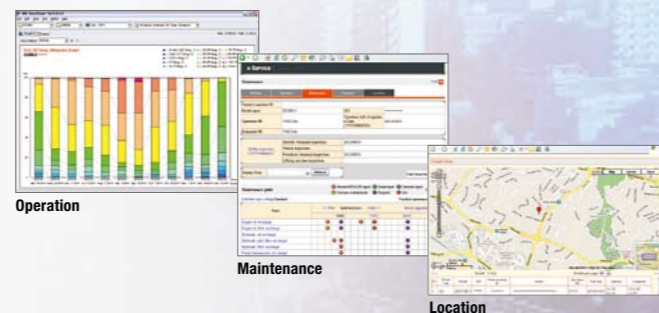

## Parts and Service

Hitachi full customer support is available every area on the globe for full customer satisfaction through Hitachi local dealers.

### Parts

Hitachi Global Online Network, a parts supply system, is linked with Japan Parts Center, overseas depots and over 150 dealers abroad to deliver on-line parts information, including in-stock parts, order receptions, shipments and delivery period of over one million parts and components.

#### Genuine Hitachi Parts

Genuine Hitachi parts, meeting Hitachi stringent quality standards, are guaranteed according to Hitachi warranty standards. The use of genuine Hitachi parts, including engine, fuel, hydraulic oil and filters, may slash running costs, and extend machine life.

#### Ground Engaging Tools (GETs)

Hitachi provides an array of Hitachi Ground Engaging Tools developed and built for a variety of applications.

Using high-quality, well-maintained GETs will help you get customers' trust.

Note: Some dealers do not handle Hitachi GETs.

#### Remanufactured Components

Hitachi components are remanufactured according to the stringent remanufacturing standards at factories around the world. They have high quality equivalent to new ones, and backed up by Hitachi warranty system.

Note: Some dealers do not handle Hitachi Remanufactured Components.

### Service

#### Extended Warranty — HELP

Hitachi Standard Warranty System is available on all new Hitachi machines. In addition, Hitachi offers Hitachi Extended Life Programs (HELPS) to suit customer expectations –

protecting machines under tough operating conditions, avoiding unexpected downtime, and reducing repair costs.

Note: Warranty conditions vary by equipment.

#### Diagnostic Tools — Maintenance Pro

Electronic control system needs quick on-site solutions, apart from mechanical repairs. Hitachi's Maintenance Pro can diagnose machine failures in a short time by plugging a PC into a failed machine.

#### Technical Training

On-site servicing matters despite locations to keep the machine at peak performance and reduce downtime. Technical Training Center (TTC), located in Japan, educates and trains service technicians and service support personnel coming from Hitachi dealers and factories on the globe according to the international training programs.







The photos above show machine images at work, which include machines other than ZAXIS 200 series.

# Various Versions

## Heavy-Duty Version: H-Series ZAXIS 210H

### Reinforced Front Attachment (H-Boom / H-Arm)

Thickened steel plates, damage prevention plates and square bars

**Thickened steel plates**  
**Reinforcement**

\*Reinforced portions not available on standard ZAXIS 200 are shown.

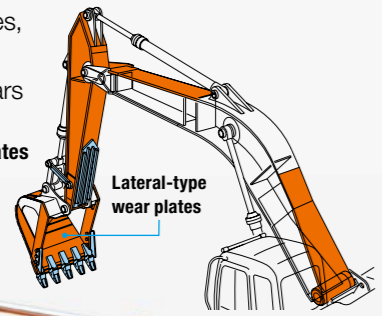

Reinforced link B

Reinforced lower flange

0.80 m<sup>3</sup> H-bucket

Thickened steel plates, additional lateral-type wear plates, and additional reinforcement plates at cutting edges

Reinforced idler bracket

600 mm reinforced triple grouser shoes

Lower cab front guard

Mechanical suspension seat

400 kg heavier counterweight

Reinforced side step (bolted)

Reinforced track guards (2 on each side)

## Demolition Version: K-Series ZAXIS 210k

### Reinforced Front Attachment (K-Boom / K-Arm)

Thickened steel plates, and damage prevention plates

Attachment basic piping

Reinforced link B for demolition

Reinforced lower flange

0.80 m<sup>3</sup> reinforced bucket

Twin wipers

Breaker and crusher piping

High-performance full-flow filters with restriction indicators

9.0 mm reinforced track undercover

600 mm reinforced triple grouser shoes

K-cab (Cab with overhead window & guard)

Lower cab front guard

400 kg heavier counterweight

6.0 mm reinforced undercover

Reinforced side step (bolted)

Reinforced idler bracket

Notes : Photo shown model equipped with optional accessories for breaker and crusher. For more details, contact your dealer.

# SPECIFICATIONS

## ENGINE

Model .....	Isuzu CC-6BG1T
Type .....	4-cycle water-cooled, direct injection
Aspiration .....	Turbocharged, intercooled
No. of cylinders .....	6
Rated power	
ISO 9249, net .....	125 kW (168 HP) at 2 100 min <sup>-1</sup> (rpm)
SAE J1349, net .....	125 kW (168 HP) at 2 100 min <sup>-1</sup> (rpm)
Maximum torque .....	637 Nm (65 kgfm) at 1 800 min <sup>-1</sup> (rpm)
Piston displacement ..	6.494 L
Bore and stroke .....	105 mm x 125 mm
Batteries .....	2 x 12 V / 88 Ah

## HYDRAULIC SYSTEM

### Hydraulic Pumps

Main pumps .....	2 variable displacement axial piston pumps
Maximum oil flow ..	2 x 212 L/min
Pilot pump .....	1 gear pump
Maximum oil flow ..	33.6 L/min

### Hydraulic Motors

Travel .....	2 variable displacement axial piston motors
Swing .....	1 axial piston motor

### Relief Valve Settings

Implement circuit .....	34.3 MPa (350 kgf/cm <sup>2</sup> )
Swing circuit .....	34.3 MPa (350 kgf/cm <sup>2</sup> )
Travel circuit .....	34.3 MPa (350 kgf/cm <sup>2</sup> )
Pilot circuit .....	3.9 MPa (40 kgf/cm <sup>2</sup> )
Power boost .....	38.0 MPa (388 kgf/cm <sup>2</sup> )

### Hydraulic Cylinders

	Quantity	Bore	Rod diameter
Boom	2	120 mm	85 mm
Arm	1	135 mm	95 mm
Bucket	1	115 mm	80 mm

## UPPERSTRUCTURE

### Revolving Frame

D-section frame skirt for resistance to deformation.

### Swing Device

Axial piston motor with planetary reduction gear is bathed in oil. Swing circle is single-row. Swing parking brake is spring-set/hydraulic-released disc type.

Swing speed .....	13.5 min <sup>-1</sup> (rpm)
Swing torque .....	68 kNm (6 900 kgfm)

### Operator's Cab

Independent spacious cab, 1 005 mm wide by 1 675 mm high, conforming to ISO\* Standards.

\* International Organization for Standardization

## UNDERCARRIAGE

### Tracks

Heat-treated connecting pins with dirt seals. Hydraulic (grease) track adjusters with shock-absorbing recoil springs.

### Numbers of Rollers and Shoes on Each Side

Upper rollers .....	2
Lower rollers .....	7 : ZX200-5G/ZX210H-5G/ZX210K-5G 8 : ZX200LC-5G/ZX210LCH-5G/ ZX210LCK-5G
Track shoes .....	46 : ZX200-5G/ZX210H-5G/ZX210K-5G 49 : ZX200LC-5G/ZX210LCH-5G/ZX210LCK-5G
Track guard .....	1 : ZX200-5G/ZX200LC-5G/ZX210K-5G/ ZX210LCK-5G 2 : ZX210H-5G/ZX210LCH-5G

### Travel Device

Each track driven by 2-speed axial piston motor. Parking brake is spring-set/hydraulic-released disc type. Automatic transmission system: High-Low.

Travel speeds .....	High : 0 to 5.5 km/h Low : 0 to 3.5 km/h
---------------------	---

Maximum traction force .. 203 kN (20 700 kgf)

Gradeability .....

## SERVICE REFILL CAPACITIES

Fuel tank .....	400.0 L
Engine coolant .....	23.0 L
Engine oil .....	25.0 L
Swing device .....	6.2 L
Travel device (each side).....	6.8 L
Hydraulic system .....	240.0 L
Hydraulic oil tank .....	135.0 L

## WEIGHTS AND GROUND PRESSURE

### Operating weight and Ground pressure

Shoe type	Shoe width	Arm length	ZX200-5G <sup>*1</sup>		ZX200LC-5G <sup>*1</sup>	
			kg	kPa(kgf/cm <sup>2</sup> )	kg	kPa(kgf/cm <sup>2</sup> )
Triple grouser	600 mm	2.42 m	19 700	44 (0.45)	20 300	42 (0.43)
		2.91 m	19 800	44 (0.45)	20 400	42 (0.43)
	700 mm	2.42 m	20 100	38 (0.39)	20 700	37 (0.38)
		2.91 m	20 200	39 (0.40)	20 700	37 (0.38)
	800 mm	2.42 m	20 400	34 (0.35)	21 000	32 (0.33)
		2.91 m	20 500	34 (0.35)	21 000	32 (0.33)
Reinforced Triple grouser	600 mm	2.42 m	—	—	—	—
		2.91 m	—	—	—	—
Triangular	760 mm	2.42 m	20 800	36 (0.37)	21 400	34 (0.35)
		2.91 m	20 800	36 (0.37)	21 400	34 (0.35)
Flat	600 mm	2.42 m	20 600	46 (0.47)	21 200	44 (0.45)
		2.91 m	20 600	46 (0.47)	21 200	44 (0.45)
Pad crawler	600 mm	2.42 m	20 000	44 (0.45)	21 000	43 (0.44)
		2.91 m	20 100	45 (0.46)	21 100	43 (0.44)

Shoe type	Shoe width	Arm length	ZX210H-5G <sup>*2</sup>		ZX210LCH-5G <sup>*2</sup>		ZX210K-5G <sup>*3</sup>		ZX210LCK-5G <sup>*3</sup>	
			kg	kPa(kgf/cm <sup>2</sup> )	kg	kPa(kgf/cm <sup>2</sup> )	kg	kPa(kgf/cm <sup>2</sup> )	kg	kPa(kgf/cm <sup>2</sup> )
Reinforced Triple grouser	600 mm	2.91 m	21 100	47 (0.48)	21 500	44 (0.45)	21 100	47 (0.48)	21 500	44 (0.45)

\*1 :Including 0.80 m<sup>3</sup> (ISO heaped) bucket weight (660 kg) and counterweight (4 200kg).

\*2 :Including 0.80 m<sup>3</sup> (ISO heaped) H-bucket weight (760 kg) and counterweight (4 600kg).

\*3 :Including 0.80 m<sup>3</sup> (ISO heaped) reinforced bucket weight (750 kg) and counterweight (4 600kg).

# SPECIFICATIONS

## WEIGHT: BASIC MACHINE and COMPONENTS

### Basic Machine Weight and Overall width

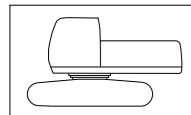

Excluding front-end attachment, fuel, hydraulic oil, coolant, etc., and including counterweight.

#### ZX200-5G

Shoe width	Weight	Overall width
600 mm	15 400 kg	2 860 mm
700 mm	15 800 kg	2 910 mm
800 mm	16 000 kg	3 000 mm

#### ZX210H-5G

Shoe width	Weight	Overall width
600 mm	16 300 kg	2 860 mm

#### ZX210K-5G

Shoe width	Weight	Overall width
600 mm	16 300 kg	2 860 mm

#### ZX200LC-5G

Shoe width	Weight	Overall width
600 mm	15 900 kg	2 990 mm
700 mm	16 300 kg	3 090 mm
800 mm	16 600 kg	3 190 mm

#### ZX210LCH-5G

Shoe width	Weight	Overall width
600 mm	16 800 kg	2 990 mm

#### ZX210LCK-5G

Shoe width	Weight	Overall width
600 mm	16 800 kg	2 990 mm

### Component weights

	ZX200-5G / ZX200LC-5G	ZX210H-5G / ZX210LCH-5G	ZX210K-5G / ZX210LCK-5G
Counterweight	4 200 kg	4 600 kg	4 600 kg
Boom (with boom and arm cylinder)	2 180 kg	2 280 kg	2 230 kg
2.42 m arm (with bucket cylinder)	850 kg	—	—
2.91 m arm (with bucket cylinder)	920 kg	1 120 kg	1 140 kg
0.80 m <sup>3</sup> bucket	660 kg	760 kg	750 kg

## BUCKET AND ARM DIGGING FORCES

Arm length	2.42 m	2.91 m
Bucket digging force* ISO	158 kN (16 200 kgf)	158 kN (16 200 kgf)
Bucket digging force* SAE : PCSA	141 kN (14 400 kgf)	141 kN (14 400 kgf)
Arm crowd force* ISO	140 kN (14 200 kgf)	114 kN (11 600 kgf)
Arm crowd force* SAE : PCSA	133 kN (13 600 kgf)	110 kN (11 200 kgf)

\* At power boost

## BACKHOE ATTACHMENTS

Boom and arms are of welded, box-section design. 5.68 m boom, and 2.42 m and 2.91 m arms are available. Bucket is of welded steel structure. Side clearance adjust mechanism provided on the bucket joint bracket.

### Buckets

Capacity	Width		No. Of teeth	Weight	Recommendation						
					ZX200-5G		ZX200LC-5G		ZX210H-5G ZX210LCH-5G	ZX210K-5G ZX210LCK-5G	
					2.42 m arm	2.91 m arm	2.42 m arm	2.91 m arm	2.91 m H-arm	2.91 m K-arm	
ISO heaped	Without side cutters	With side cutters									
0.51 m <sup>3</sup>	720 mm	830 mm	3	530 kg	⊙	⊙	⊙	⊙	⊙	⊙	⊙
0.80 m <sup>3</sup>	1 030 mm	1 140 mm	5	660 kg	⊙	⊙	⊙	⊙	⊙	⊙	⊙
0.91 m <sup>3</sup>	1 150 mm	1 260 mm	5	700 kg	⊙	○	⊙	⊙	○	⊙	○
1.10 m <sup>3</sup>	1 330 mm	1 440 mm	6	770 kg	□	—	○	○	—	○	—
1.20 m <sup>3</sup>	1 450 mm	—	6	690 kg	□	—	□	—	—	—	—
*1 0.80 m <sup>3</sup>	1 030 mm	1 140 mm	5	750 kg	⊙	⊙	⊙	⊙	⊙	⊙	⊙
*1 0.91 m <sup>3</sup>	1 150 mm	1 260 mm	5	800 kg	⊙	○	⊙	⊙	○	⊙	○
*2 0.80 m <sup>3</sup>	1 040 mm	1 150 mm	5	760 kg	⊙	⊙	⊙	⊙	⊙	⊙	⊙
*3 0.80 m <sup>3</sup>	1 030 mm	1 140 mm	5	660 kg	⊙	⊙	⊙	⊙	⊙	⊙	⊙
*4 0.80 m <sup>3</sup>	1 040 mm	1 150 mm	5	760 kg	⊙	⊙	⊙	⊙	⊙	⊙	⊙
*5 0.60 m <sup>3</sup>	800 mm	—	3	950 kg	●	—	●	—	—	—	—
One-point ripper			1	540 kg	●	—	●	—	—	—	—
Slope-finishing blade: Width 1 100 mm, length 1 800 mm			—	590 kg	◇	◇	◇	◇	◇	◇	—
V shape Bucket:			3	520 kg	○	○	○	○	○	○	—
Center-pull type clamshell bucket: 0.60 m <sup>3</sup> (CECE heaped), Width 940 mm			8	1 130 kg	⊙	⊙	⊙	⊙	⊙	⊙	⊙
Shell-push type clamshell bucket: 0.60 m <sup>3</sup> (CECE heaped), Width 870 mm			7	960 kg	⊙	⊙	⊙	⊙	⊙	⊙	⊙

\*1 H-bucket

\*2 Reinforced bucket

\*3 Level-pin-type bucket

\*4 Super V teeth type bucket

\*5 Ripper bucket

⊙ Suitable for materials with density of 2 000 kg/m<sup>3</sup> or less

○ Suitable for materials with density of 1 600 kg/m<sup>3</sup> or less

□ Suitable for materials with density of 1 100 kg/m<sup>3</sup> or less

● Heavy-duty service

◇ Slope-finishing service

— Not applicable

# SPECIFICATIONS

## WORKING RANGES

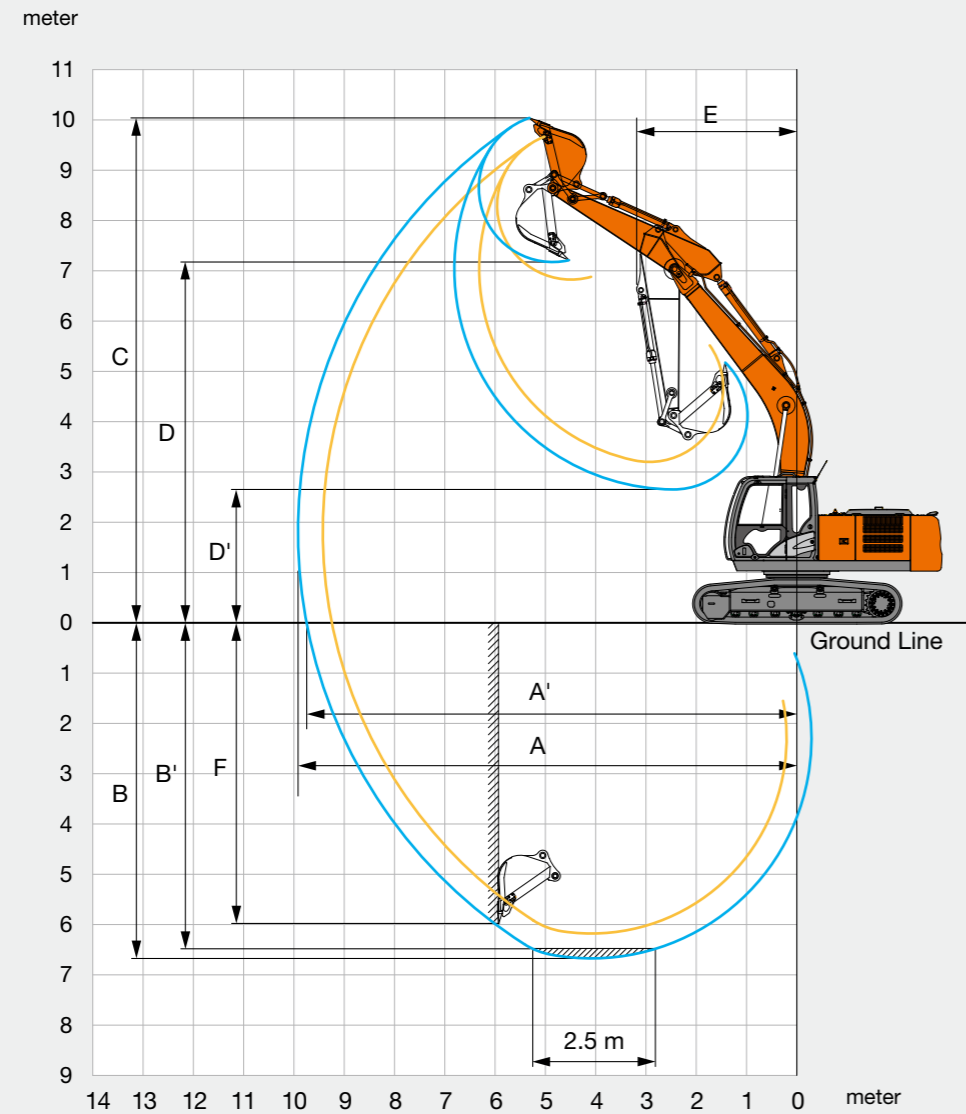

Arm length	2.42 m	2.91 m
A Max. digging reach	9 430	9 920
A' Max. digging reach (on ground)	9 250	9 750
B Max. digging depth	6 180	6 670
B' Max. digging depth for 2.5 m level	5 950	6 490
C Max. cutting height	9 670	10 040
D Max. dumping height	6 830	7 180
D' Min. dumping height	3 200	2 650
E Min. swing radius	3 280	3 180
F Max. vertical wall digging depth	5 300	5 990

Excluding track shoe lug

## DIMENSIONS

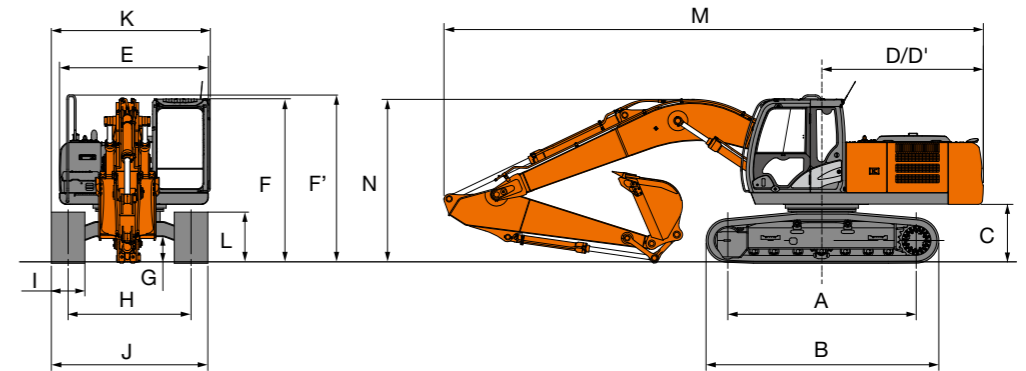

Unit: mm

	ZX200-5G	ZX200LC-5G	ZX210H-5G	ZX210LCH-5G	ZX210K-5G	ZX210LCK-5G
A Distance between tumblers	3 370	3 660	3 370	3 660	3 370	3 660
B Undercarriage length	4 170	4 470	4 170	4 470	4 170	4 470
* C Counterweight clearance	1 030	1 030	1 030	1 030	1 030	1 030
D Rear-end swing radius	2 890	2 890	2 890	2 890	2 890	2 890
D' Rear-end length	2 890	2 890	2 890	2 890	2 890	2 890
E Overall width of upperstructure	2 710	2 710	2 710	2 710	2 710	2 710
F Overall height of cab	2 950	2 950	2 950	2 950	2 950	2 950
F' Overall height of upperstructure	3 010	3 010	3 010	3 010	3 010	3 010
* G Min. ground clearance	450	450	450	450	450	450
H Track gauge	2 200	2 390	2 200	2 390	2 200	2 390
I Track shoe width	G 600	G 600	G 600	G 600	G 600	G 600
J Undercarriage width	2 800	2 990	2 800	2 990	2 800	2 990
K Overall width	2 860	2 990	2 860	2 990	2 860	2 990
* L Track height with triple grouser shoes	920	920	920	920	920	920
M Overall length						
With 2.42 m arm	9 750	9 750	—	—	—	—
With 2.91 m arm	9 660	9 660	9 660	9 660	9 660	9 660
N Overall height of boom						
With 2.42 m arm	3 180	3 180	—	—	—	—
With 2.91 m arm	2 940	2 940	2 940	2 940	2 940	2 940

\* Excluding track shoe lug    G: Triple grouser shoe

# LIFTING CAPACITIES (Without Bucket)

- Notes: 1. Ratings are based on ISO 10567.  
 2. Lifting capacity does not exceed 75% of tipping load with the machine on firm, level ground or 87% full hydraulic capacity.  
 3. The load point is the center-line of the bucket pivot mounting pin on the arm.  
 4. \*Indicates load limited by hydraulic capacity.  
 5. 0 m = Ground.

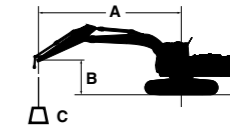

A: Load radius  
 B: Load point height  
 C: Lifting capacity

For lifting capacities, subtract bucket and quick hitch weight from lifting capacities without bucket.

**ZX200-5G** Rating over-front Rating over-side or 360 degrees Unit : kg

Conditions	Load point height m	Load radius m										At max. reach		
		1.5		3.0		4.5		6.0		7.5		meter		
		Rating over-front	Rating over-side or 360 degrees	Rating over-front	Rating over-side or 360 degrees	Rating over-front	Rating over-side or 360 degrees	Rating over-front	Rating over-side or 360 degrees	Rating over-front	Rating over-side or 360 degrees			
Boom 5.68 m	6.0							*5 750	4 600			5 620	3 780	6.75
Arm 2.42 m	4.5					*7 340	6 870	*6 230	4 450			4 690	3 130	7.49
Counterweight 4 200 kg	3.0					*9 210	6 340	6 450	4 230	4 590	3 050	4 260	2 830	7.87
Shoe 600 mm	1.5					9 610	5 910	6 210	4 010	4 490	2 950	4 120	2 710	7.96
	0 (Ground)					9 390	5 720	6 060	3 880	4 420	2 890	4 230	2 770	7.74
	-1.5			*9 910	*9 910	9 370	5 710	6 020	3 840			4 670	3 040	7.21
	-3.0			*13 220	11 060	9 490	5 810	6 110	3 930			5 740	3 710	6.28
	-4.5					*6 880	6 100					*6 450	5 730	4.71
	-6.0													
Boom 5.68 m	6.0							*5 220	4 670			*4 030	3 330	7.33
Arm 2.91 m	4.5					*6 610	*6 610	*5 780	4 510	4 720	3 160	*3 980	2 830	8.01
Counterweight 4 200 kg	3.0					*8 530	6 480	6 500	4 270	4 610	3 060	3 880	2 570	8.37
Shoe 600 mm	1.5					9 720	6 000	6 240	4 040	4 490	2 950	3 760	2 470	8.45
	0 (Ground)			*4 850	*4 850	9 410	5 740	6 060	3 880	4 400	2 870	3 850	2 520	8.25
	-1.5	*5 480	*5 480	*9 100	*9 100	9 330	5 670	5 980	3 810	4 370	2 840	4 180	2 720	7.76
	-3.0	*9 970	*9 970	*14 390	10 890	9 400	5 730	6 020	3 840			4 960	3 220	6.90
	-4.5			*11 250	11 250	*8 120	5 930					*6 250	4 500	5.52
	-6.0													

**ZX200LC-5G** Rating over-front Rating over-side or 360 degrees Unit : kg

Conditions	Load point height m	Load radius m										At max. reach		
		1.5		3.0		4.5		6.0		7.5		meter		
		Rating over-front	Rating over-side or 360 degrees	Rating over-front	Rating over-side or 360 degrees	Rating over-front	Rating over-side or 360 degrees	Rating over-front	Rating over-side or 360 degrees	Rating over-front	Rating over-side or 360 degrees			
Boom 5.68 m	6.0							*5 750	5 080			*5 780	4 180	6.75
Arm 2.42 m	4.5					*7 340	*7 340	*6 230	4 930			5 310	3 480	7.49
Counterweight 4 200 kg	3.0					*9 210	7 100	*7 040	4 710	5 210	3 390	4 830	3 150	7.87
Shoe 600 mm	1.5					*10 720	6 660	7 110	4 490	5 100	3 300	4 680	3 030	7.96
	0 (Ground)					10 970	6 470	6 950	4 350	5 040	3 230	4 820	3 100	7.74
	-1.5			*9 910	*9 910	*10 910	6 450	6 910	4 320			5 320	3 400	7.21
	-3.0			*13 220	12 750	*9 730	6 560	7 000	4 400			6 560	4 150	6.28
	-4.5					*6 880	6 860					*6 450	6 430	4.71
	-6.0													
Boom 5.68 m	6.0							*5 220	5 150			*4 030	3 690	7.33
Arm 2.91 m	4.5					*6 610	*6 610	*5 780	4 990	5 350	3 510	*3 980	3 140	8.01
Counterweight 4 200 kg	3.0					*8 530	7 250	*6 650	4 750	5 230	3 410	*4 090	2 870	8.37
Shoe 600 mm	1.5					*10 260	6 750	7 140	4 520	5 110	3 300	4 280	2 770	8.45
	0 (Ground)			*4 850	*4 850	10 990	6 490	6 950	4 350	5 010	3 210	4 380	2 820	8.25
	-1.5	*5 480	*5 480	*9 100	*9 100	10 900	6 410	6 870	4 280	4 980	3 180	4 760	3 050	7.76
	-3.0	*9 970	*9 970	*14 390	12 580	*10 230	6 470	6 910	4 310			5 670	3 610	6.90
	-4.5			*11 250	*11 250	*8 120	6 690					*6 250	5 040	5.52
	-6.0													

**ZX210H-5G** Rating over-front Rating over-side or 360 degrees Unit : kg

Conditions	Load point height m	Load radius m										At max. reach		
		1.5		3.0		4.5		6.0		7.5		meter		
		Rating over-front	Rating over-side or 360 degrees	Rating over-front	Rating over-side or 360 degrees	Rating over-front	Rating over-side or 360 degrees	Rating over-front	Rating over-side or 360 degrees	Rating over-front	Rating over-side or 360 degrees			
H-Boom 5.68 m	6.0							*4 550	*4 550			*3 970	3 530	7.33
H-Arm 2.91 m	4.5					*5 790	*5 790	*5 030	4 780	*4 680	3 360	*3 910	3 000	8.01
Counterweight 4 600 kg	3.0					*7 460	6 900	*5 790	4 550	4 890	3 250	*4 030	2 730	8.37
Shoe 600 mm	1.5					*8 970	6 410	*6 550	4 310	4 760	3 140	3 990	2 630	8.45
	0 (Ground)			*4 790	4 790	*9 720	6 140	6 450	4 140	4 670	3 050	4 080	2 680	8.25
	-1.5	*5 420	5 420	*9 040	9 040	*9 690	6 070	6 370	4 070	4 640	3 030	4 440	2 900	7.76
	-3.0	*9 910	9 910	*12 580	11 680	*8 920	6 130	6 410	4 100			5 270	3 430	6.90
	-4.5			*9 780	9 780	*7 040	6 340					*5 390	4 800	5.52
	-6.0													

**ZX210LCH-5G** Rating over-front Rating over-side or 360 degrees Unit : kg

Conditions	Load point height m	Load radius m										At max. reach						
		1.5		3.0		4.5		6.0		7.5		meter						
		Rating over-front	Rating over-side or 360 degrees	Rating over-front	Rating over-side or 360 degrees	Rating over-front	Rating over-side or 360 degrees	Rating over-front	Rating over-side or 360 degrees	Rating over-front	Rating over-side or 360 degrees							
H-Boom 5.68 m	6.0											*4 550	*4 550	*3 970	3 900	7.33		
H-Arm 2.91 m	4.5							*5 790	*5 790	*5 030	*5 030	*4 680	3 710	*3 910	3 320	8.01		
Counterweight 4 600 kg	3.0							*7 460	*7 460	*5 790	5 030	*4 990	3 600	*4 030	3 030	8.37		
Shoe 600 mm	1.5							*8 970	7 180	*6 550	4 790	*5 360	3 490	*4 300	2 930	8.45		
	0 (Ground)							*4 790	*4 790	*9 720	6 900	*7 060	4 620	5 290	3 400	4 620	2 980	8.25
	-1.5	*5 420	*5 420	*9 040	*9 040	*9 690	6 830	*7 130	4 550	5 260	3 370	*5 030	3 230	*5 030	3 230	7.76		
	-3.0	*9 910	*9 910	*12 580	*12 580	*8 920	6 890	*6 590	4 580			*5 410	3 820	*5 410	3 820	6.90		
	-4.5			*9 780	*9 780	*7 040	*7 040					*5 390	5 350	*5 390	5 350	5.52		
	-6.0																	

**ZX210K-5G** Rating over-front Rating over-side or 360 degrees Unit : kg

Conditions	Load point height m	Load radius m										At max. reach						
		1.5		3.0		4.5		6.0		7.5		meter						
		Rating over-front	Rating over-side or 360 degrees	Rating over-front	Rating over-side or 360 degrees	Rating over-front	Rating over-side or 360 degrees	Rating over-front	Rating over-side or 360 degrees	Rating over-front	Rating over-side or 360 degrees							
K-Boom 5.68 m	6.0											*4 550	*4 550	*3 970	3 530	7.33		
K-Arm 2.91 m	4.5							*5 790	*5 790	*5 030	4 780	*4 680	3 360	*3 910	3 000	8.01		
Counterweight 4 600 kg	3.0							*7 460	6 900	*5 790	4 550	4 890	3 250	*4 030	2 730	8.37		
Shoe 600 mm	1.5							*8 970	6 410	*6 550	4 310	4 760	3 140	3 990	2 630	8.45		
	0 (Ground)							*4 790	4 790	*9 720	6 140	6 450	4 140	4 670	3 050	4 080	2 680	8.25
	-1.5	*5 420	5 420	*9 040	9 040	*9 690	6 070	6 370	4 070	4 640	3 030	4 440	2 900	7.76				
	-3.0	*9 910	9 910	*12 580	11 680	*8 920	6 130	6 410	4 100			5 270	3 430	6.90				
	-4.5			*9 780	9 780	*7 040	6 340					*5 390	4 800	5.52				
	-6.0																	

**ZX210LCK-5G** Rating over-front Rating over-side or 360 degrees Unit : kg

Conditions	Load point height m	Load radius m										At max. reach						
		1.5		3.0		4.5		6.0		7.5		meter						
		Rating over-front	Rating over-side or 360 degrees	Rating over-front	Rating over-side or 360 degrees	Rating over-front	Rating over-side or 360 degrees	Rating over-front	Rating over-side or 360 degrees	Rating over-front	Rating over-side or 360 degrees							
K-Boom 5.68 m	6.0											*4 550	*4 550	*3 970	3 900	7.33		
K-Arm 2.91 m	4.5							*5 790	*5 790	*5 030	*5 030	*4 680	3 710	*3 910	3 320	8.01		
Counterweight 4 600 kg	3.0							*7 460	*7 460	*5 790	5 030	*4 990	3 600	*4 030	3 030	8.37		
Shoe 600 mm	1.5							*8 970	7 180	*6 550	4 790	*5 360	3 490	*4 300	2 930	8.45		
	0 (Ground)							*4 790	*4 790	*9 720	6 900	*7 060	4 620	5 290	3 400	4 620	2 980	8.25
	-1.5	*5 420	*5 420	*9 040	*9 040	*9 690	6 830	*7 130	4 550	5 260	3 370	*5 030	3 230	*5 030	3 230	7.76		
	-3.0	*9 910	*9 910	*12 580	*12 580	*8 920	6 890	*6 590	4 580			*5 410	3 820	*5 410	3 820	6.90		
	-4.5			*9 780	*9 780	*7 040	*7 040					*5 390	5 350	*5 390	5 350	5.52		
	-6.0																	

# EQUIPMENT

Standard and optional equipment may vary by country, so please consult your Hitachi dealer for details.

● : Standard equipment      ○ : Optional equipment

	ZX200-5G / ZX200LC-5G	ZX210H-5G / ZX210LCH-5G	ZX210K-5G / ZX210LCK-5G
<b>ENGINE</b>			
Air cleaner double filters	●	●	●
Auto idle system	●	●	●
Cartridge-type engine oil filter	●	●	●
Cartridge-type fuel pre-filter	●	●	●
Cartridge-type fuel main filter	●	●	●
Dry-type air filter with evacuator valve (with air filter restriction indicator)	●	●	●
ECO/PWR mode control	●	●	●
Engine warm-up device	●	●	●
Fan guard	●	●	●
Water separator	●	●	●
Pre-cleaner	○	○	○
Dust-Proof indoor net	●	●	●
Radiator reserve tank	●	●	●
50 A alternator	●	●	●
<b>HYDRAULIC SYSTEM</b>			
Auto power lift	●	●	●
Control valve with main relief valve	●	●	●
Full-flow filter	●	●	●
High mesh full flow filter with restriction indicator	○	○	●
Pilot filter	●	●	●
Power boost	●	●	●
Suction filter	●	●	●
One extra port for control valve	●	●	●
Work mode selector	●	●	●

	ZX200-5G / ZX200LC-5G	ZX210H-5G / ZX210LCH-5G	ZX210K-5G / ZX210LCK-5G
<b>CAB</b>			
All-weather sound suppressed steel cab	●	●	●
AM-FM radio with 2 speaker	●	●	●
Ashtray	●	●	●
Auto control air conditioner	●	●	●
AUX. terminal and storage	○	○	○
Cab (Center pillar reinforced structure)	●	●	●
Drink holder	●	●	●
Drink holder with hot & cool	●	●	●
Electric double horn	●	●	●
Engine shut-off lever	●	●	●
Evacuation hammer	●	●	●
Fire extinguisher bracket	○	○	○
Floor mat	●	●	●
Footrest	●	●	●
Front window washer	●	●	●
Front windows on upper, lower and left side can be opened	●	●	●
Lower cab front guard	○	●	●
Upper cab front guard	○	○	○
Glove compartment	●	●	●
Hot & cool box	●	●	●
Intermittent windshield wipers	●	●	●
Key cylinder light	●	●	●
K-cab. (CRES III cab with overhead window & guard)	—	—	●
LED room light with door courtesy	●	●	●
OPG top guard Level I (ISO10262) compliant cab	●	●	●
Pilot control shut-off lever	●	●	●
Rear tray	●	●	●
Retractable seat belt	●	●	●
Rubber radio antenna	●	●	●
Seat : Fabric seat	●	—	—
Seat : mechanical suspension seat	○	●	●
Seat : air suspension seat with heater	○	○	○
Seat adjustment part : backrest, armrest, height and angle, slide forward / back	●	●	●
Short wrist control levers	●	●	●
Twin wiper	—	—	●
4 fluid-filled elastic mounts	●	●	●
24V cigarette lighter	●	●	●

	ZX200-5G / ZX200LC-5G	ZX210H-5G / ZX210LCH-5G	ZX210K-5G / ZX210LCK-5G
<b>MONITOR SYSTEM</b>			
Alarm buzzers: overhear, engine oil pressure, overload	●	●	●
Alarms: overhear, engine warning, engine oil pressure, alternator, minimum fuel level, hydraulic filter restriction, air filter restriction, work mode, overload, etc	●	●	●
Display of meters: water temperature, hour, fuel rate, clock	●	●	●
Other displays: work mode, auto-idle, glow, rearview monitor, operating conditions, etc	●	●	●
32 languages selection	●	●	●
<b>LIGHTS</b>			
Additional cab roof front lights	○	○	○
Additional boom light with cover	○	○	○
2 working lights	●	●	●
<b>UPPER STRUCTURE</b>			
Electric fuel refilling pump	○	○	○
Fuel level float	●	●	●
Hydraulic oil level gauge	●	●	●
Rear view camera	○	○	○
Rear view mirror (right & left side)	●	●	●
Swing parking brake	●	●	●
Tool box	●	●	●
Undercover	●	●	●
6.0 mm reinforced undercover	○	●	●
Utility space	●	●	●
4 200 kg counterweight	●	—	—
4 600 kg counterweight	○	●	●
2 x 88 Ah batteries	●	●	●

	ZX200-5G / ZX200LC-5G	ZX210H-5G / ZX210LCH-5G	ZX210K-5G / ZX210LCK-5G
<b>UNDERCARRIAGE</b>			
Bolt-on sprocket	●	●	●
Reinforced track links with pin seals	●	●	●
Reinforced lower flange	—	●	●
Reinforced idler bracket	—	●	●
Travel motor covers	●	●	●
Travel parking brake	●	●	●
9.0 mm reinforced track undercover	○	○	●
Track guard (each side) and hydraulic track adjuster	●	●	●
Upper and lower rollers	●	●	●
2 track guards	○	●	○
4 tie down hooks	●	●	●
600 mm triple grouser shoes	●	Reinforced	Reinforced
Reinforced side step	—	●	●
<b>FRONT ATTACHMENTS</b>			
Centralized lubrication system	●	●	●
Dirt seal on all bucket pins	●	●	●
Flanged pin	●	●	●
HN bushing	●	●	●
Reinforced resin thrust plate	●	●	●
Reinforced link B	—	●	● for demolition
WC (tungsten-carbide) thermal spraying	●	●	●
0.80 m <sup>3</sup> bucket (ISO heaped)	●	H-bucket	Reinforced bucket
2.91 m arm	●	H-arm	K-arm
5.68 m boom	●	H-boom	K-boom
<b>ATTACHMENTS</b>			
Attachment basic piping	○	○	●
Breaker and crusher piping	○	○	●
High mesh full flow filter with restriction indicator	○	○	●
Parts for breaker and crusher	○	○	○
2 pump combined flow for attachment basic piping	○	○	○
Line filter	○	○	○
<b>MISCELLANEOUS</b>			
Lockable fuel refilling cap	●	●	●
Lockable machine covers	●	●	●
Onboard information controller	●	●	●
Skid-resistant tapes, plates and handrails	●	●	●
Standard tool kit	●	●	●
Travel direction mark on track frame	●	●	●
Global e-Service	●	●	●



**Built on the foundation of superb technological capabilities, Hitachi Construction Machinery is committed to providing leading-edge solutions and services to contribute as a reliable partner to the business of customers worldwide.**

## Hitachi Environmental Vision 2025

The Hitachi Group released the Environmental Vision 2025 to curb annual carbon dioxide emissions. The Group is committed to global production while reducing environmental impact in life cycles of all products, and realizing a sustainable society by tackling three goals — prevention of global warming, conservation of resources, and preservation of ecosystem.

### Reducing Environmental Impact by New ZAXIS

Hitachi makes a green way to cut carbon emissions for global warming prevention according to LCA\*. New ZAXIS utilizes lots of technological advances, including the new ECO mode, and Isochronous Control. Hitachi has long been committed to recycling of components, such as aluminum parts in radiators and oil cooler. Resin parts are marked for recycling.

\*Life Cycle Assessment – ISO 14040

Before using a machine with a satellite communication system, please make sure that the satellite communication system complies with local regulations, safety standards and legal requirements. If not so, please make modifications accordingly.

These specifications are subject to change without notice. Illustrations and photos show the standard models, and may or may not include optional equipment, accessories, and all standard equipment with some differences in color and features. Before use, read and understand the Operator's Manual for proper operation.