



**HAMM**

# The agile all-rounders **SERIES HD COMPACTLINE**





# The wasp-waist rollers

Smart compaction in confined spaces



Clear view of the drum edges - thanks to the wasp waist!

On the HD 8 and HD 10C, the smallest models in the series, the drums feature single-sided suspension and are laterally offset from one another. This means that no part of the machine extends beyond the working width. Due to this design, the steering wheel can be turned even when right alongside edges, making the roller manoeuvrable at all times.

With their compact dimensions, great compaction force and generous side clearance, the HD 8 - HD 14 tandem rollers in the HD CompactLine live up to their name. They can work almost anywhere, even when space is at a premium. What makes this possible is their extremely compact design. In addition, their low profile allows them to compact in sites with limited headroom. And with the optional tiltable ROPS, they make themselves even smaller for transportation.



The HD CompactLine offers copious elbowroom and ergonomically optimised working conditions for every driver.

## Maximum possible space for the driver

### Compact rollers with the feel-good factor

In addition to the outstanding view, the innovative wasp-waist shape brings even more benefits such as the comfortable sitting position with copious elbowroom and a forward/backward sliding seat that can also be moved sideways on the larger models. There is also plenty of space even for long legs, and room to move the arms, even with the driver's seat moved up to the outer edge of the platform.

The driver's seat, steering column, control lever and footplate are mechanically isolated from the frame. This significantly reduces the vibration felt by the driver and makes operating an HD CompactLine roller a pleasure, even when working for long periods at a stretch. This, in combination with the 3-point articulation, which provides effective shock absorption, means that drivers experience unrivalled driving comfort on the HD CompactLine rollers.



The central lifting point is also a convenient handrail when climbing aboard.

The driver's seat can be moved from side to side on many HD CompactLine models.

Machine vibrations are barely discernible on the mechanically isolated operator's platform.

Even tall drivers with long legs will not be short of space on the wide driver platform.

# Compact rollers with great compaction force



Elevated side panels provide plenty of side clearance when working alongside kerbs.

## The pioneer in compaction power

The drum diameters of HD CompactLine rollers are significantly larger than those of comparable rollers in this class. This prevents the formation of bulges or undulations and ensures high compaction quality.

Another impressive feature of HD CompactLine rollers is their compaction power: the centrifugal force during dynamic compaction with vibration clearly exceeds that of comparable competitor machines. In addition, all models have a high static linear load.

The 3-point articulation provides a further practical advantage by distributing the weight evenly over the front and rear drums. This also makes for exceptional directional stability, enormous stability in turns as well as great resistance to tipping. Moreover, deformation of the asphalt is avoided.

The result: a high level of safety and very smooth asphalt surfaces, even in tight curves.

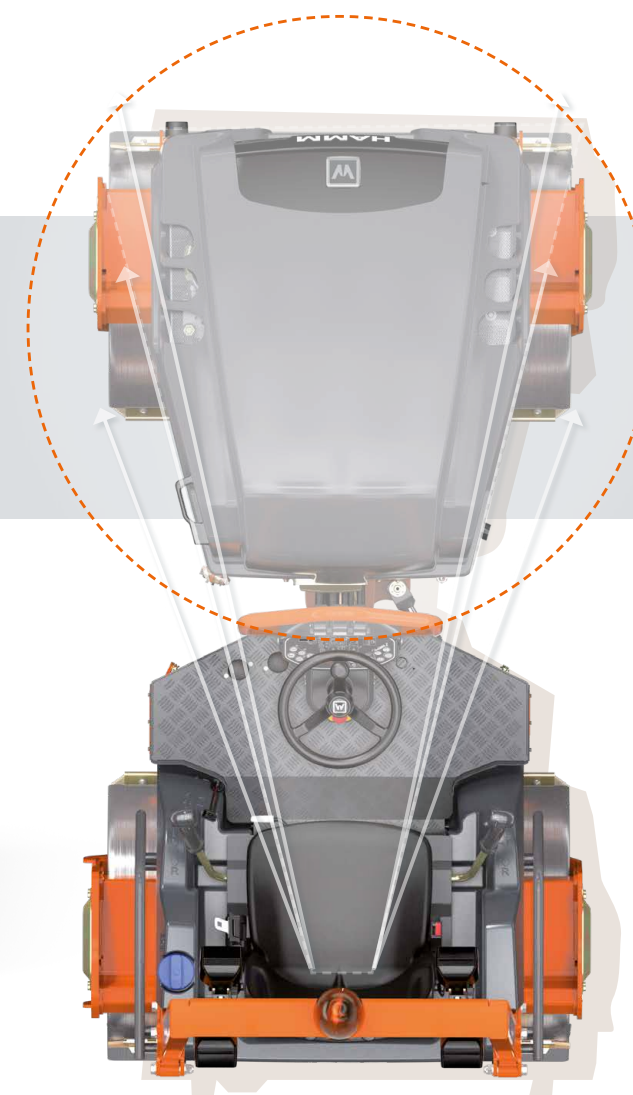

3-point articulation, high linear load and large drum diameters enable high-quality compaction to be achieved, even on small areas.



## Good side clearance as standard

All HD CompactLine rollers offer extremely good side clearance thanks to their inwardly offset suspensions. In addition, the drums with double-sided suspension employed on the rollers with an operating weight in excess of 2.5 t (HD 10 - HD 14) are able to work with a track offset of 50 mm. This enables the HD CompactLine rollers to operate close to walls, kerbs and other boundaries.

## Vibration, oscillation and combi rollers

HAMM offers a wide choice of models and drums for the HD CompactLine. The spectrum ranges from tandem rollers with two vibrating drums (VV) or tandem rollers with a vibrating and an oscillation drum (VO) to combi rollers (VT) and pneumatic tyre rollers (TT).

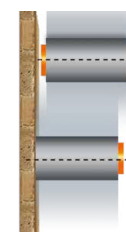

Single-sided drum suspension on the HD 8 and HD 10C models ensures complete compaction right up to the edge.

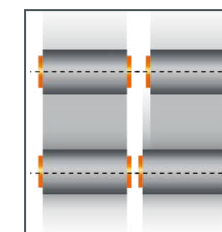

HD 10 - HD 14: a 50 mm track offset to the right side enables easy handling, especially when compacting up to the edge.



# Everything in view at all times

Drum edges and construction site under control



Drivers of HD CompactLine rollers enjoy an unrestricted view of the drum edges and the working environment in front, alongside and behind the machine. Such perfect visibility results from a clever design idea: mounting the engine longitudinally. It enables the conical engine hood shape and thus the "wasp waist".

The HD CompactLine roller is the only machine in its market segment to have been awarded two world-leading design prizes for its successful product design: the "iF Gold award" and the "Red Dot". The juries particularly praised the aesthetic appeal, which is combined with outstanding ergonomics and functionality.



## The technical highlights at a glance



### VISIBILITY

The wasp waist and longitudinally mounted engine provide an excellent view of the drum edges, machine and surrounding construction site.

### EASY TRANSPORT, EASY LOADING AND UNLOADING

Central lifting point and many lashing points for fast and safe loading/unloading.

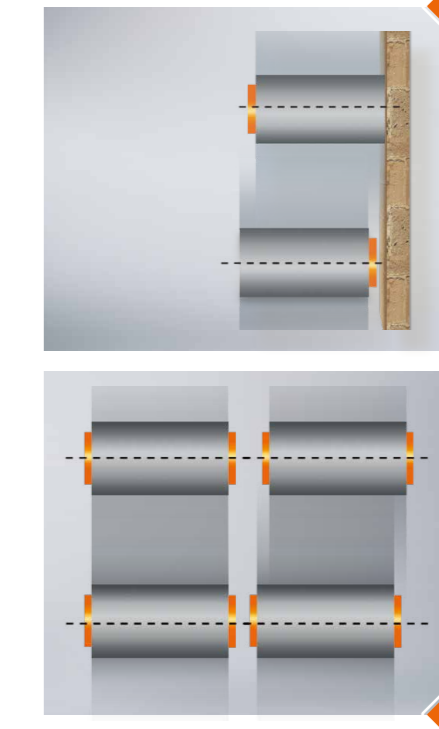

- 1** **▶ OPTIMUM VISIBILITY**  
A tapered front section and the longitudinally mounted engine allow a perfect view of the drum edges, the area around the machine and the construction site.
- 2** **▶ HANDRAIL**  
2 in 1: the handrail also serves as the central lifting point for loading and unloading (HD 8 - HD 12).
- 3** **▶ DASHBOARD**  
Language-neutral, intuitive operation. Lockable control panel cover guards against vandalism.
- 4** **▶ DRIVE LEVERS**  
Two drive levers for relaxed two-sided operation of the drive control (second lever optional on the HD 8 and HD 10C).
- 5** **▶ ROPS**  
The ROPS frame provides maximum safety. Optionally available with simple folding mechanism for maximum flexibility as to transportation.
- 6** **▶ WATER AND DIESEL TANKS**  
Generously dimensioned tanks for water and diesel. Easy, convenient filling.
- 7** **▶ OPERATOR'S PLATFORM**  
Vibration-insulated operator's platform for maximum comfort with minimal vibrations on the driver's seat, steering column, drive lever and footplate. With compartment for documents, wallet and other personal items, drinks holder and 12 V socket.

- 8** **▶ CABIN**  
Option. ROPS cabin with all-round visibility for HD 13 and HD 14.
- 9** **▶ FREEDOM OF MOVEMENT**  
Large operator's platform for maximum legroom. Seat adjustable forwards/backwards. On HD 10 - HD 14, seat also adjustable sideways, with optimal view of the sides as a result.
- 10** **▶ LARGE DRUM DIAMETERS**  
Drums with large diameters actively reduce cracking and bulging and promote high-quality compaction.
- 11** **▶ RESISTANCE TO TIPPING**  
Low centre of gravity thanks to advantageous component positioning and 3-point articulation for best possible protection against tipping.
- 12** **▶ WATER SYSTEM**  
Triple filtration with self-cleaning water filter, a filter on the filler neck and filters before the sprinkling system. Adjustment on the dashboard. Supplementary water sprinkling can be activated via a foot switch. Central water outlet at lowest point on the machine for complete draining.
- 13** **▶ 3-POINT ARTICULATION**  
Effective shock absorption, outstanding directional stability, good stability in curves, high degree of resistance to tipping and uniform weight distribution over front and rear drums.

**LARGE ROLLER DRUM DIAMETERS**  
Drums with large diameters actively reduce cracking and bulging and promote high-quality compaction.

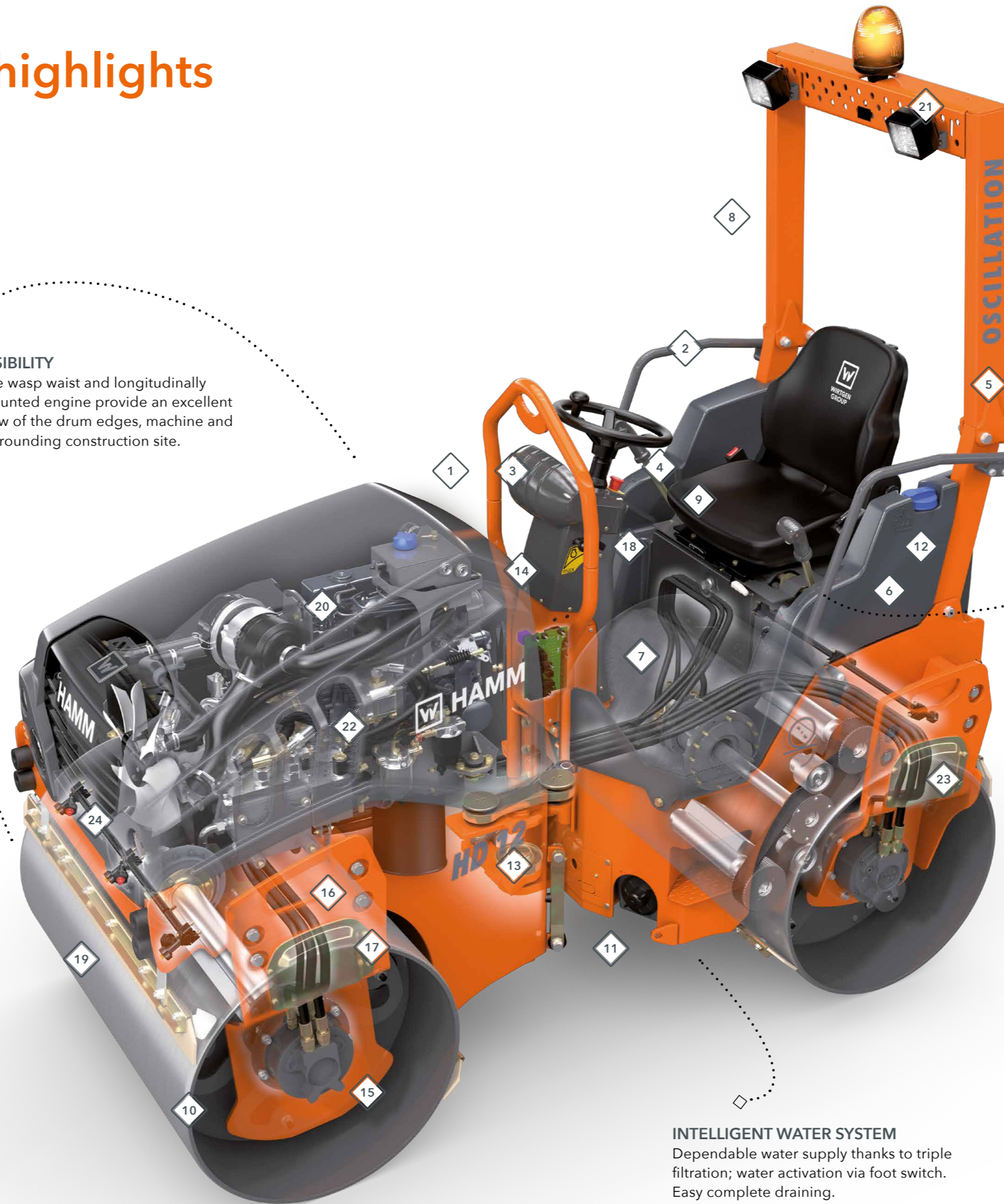

**COMPACT DIMENSIONS**  
High-quality compaction, even in cramped conditions, thanks to compact dimensions.

**INTELLIGENT WATER SYSTEM**  
Dependable water supply thanks to triple filtration; water activation via foot switch. Easy complete draining.

- 14** **▶ CENTRAL ELECTRICAL UNIT**  
Central electrical unit in the steering column. Enables speedy servicing and very simple maintenance.
- 15** **▶ EDGE PRESSING AND CUTTING EQUIPMENT**  
Option. Clearly visible edge pressing and cutting equipment for clean chamfering of the roadway. Available for HD 10 - HD 14. Also available with separately activatable sprinkling system and track indicator.
- 16** **▶ CLEAR SIDE**  
Compaction right up to the edge: single-sided drum suspension on the HD 8 and HD 10C for complete compaction right up to the edge. 56 mm drum offset makes for good steering and manoeuvrability in all situations.
- 17** **▶ TRACK OFFSET**  
Track offset on all machines from 2.5 t upwards, providing optimal manoeuvrability even next to verges, barriers and other obstructions.
- 18** **▶ VARIABLE VIBRATION FREQUENCY**  
Multi-stop accelerator. Facilitates the changing of vibration frequency at different engine speeds.

- 19** **▶ WIDE RANGE OF DRUMS**  
Available with two vibrating drums (VV), with vibrating and oscillation drums (VO) or as a combi roller (VT).
- 20** **▶ ENGINES**  
Water-cooled 3 or 4-cylinder KUBOTA engines with indirect fuel injection. The emissions comply with the applicable regulations. Low-noise, environment-friendly operation.
- 21** **▶ LIGHTING**  
Bright working spotlights on the ROPS cabin / ROPS. Halogen as standard; long-lasting, very bright LED technology also available as an option. Optional LED drum edge lighting.
- 22** **▶ AUTOMATIC ENGINE-OFF FUNCTION**  
Option. Automatic engine cut-off after an extended period of inactivity. Saves fuel and hence operating costs.
- 23** **▶ ALL-WHEEL DRIVE LOCK**  
Option. Manually activated all-wheel drive lock for operation in steep terrain.
- 24** **▶ HCQ MODULES**  
Option. HAMM Compaction Meter (HCM) for compaction monitoring and HAMM Temperature Meter (HTM) for asphalt temperature measurement available for various models.

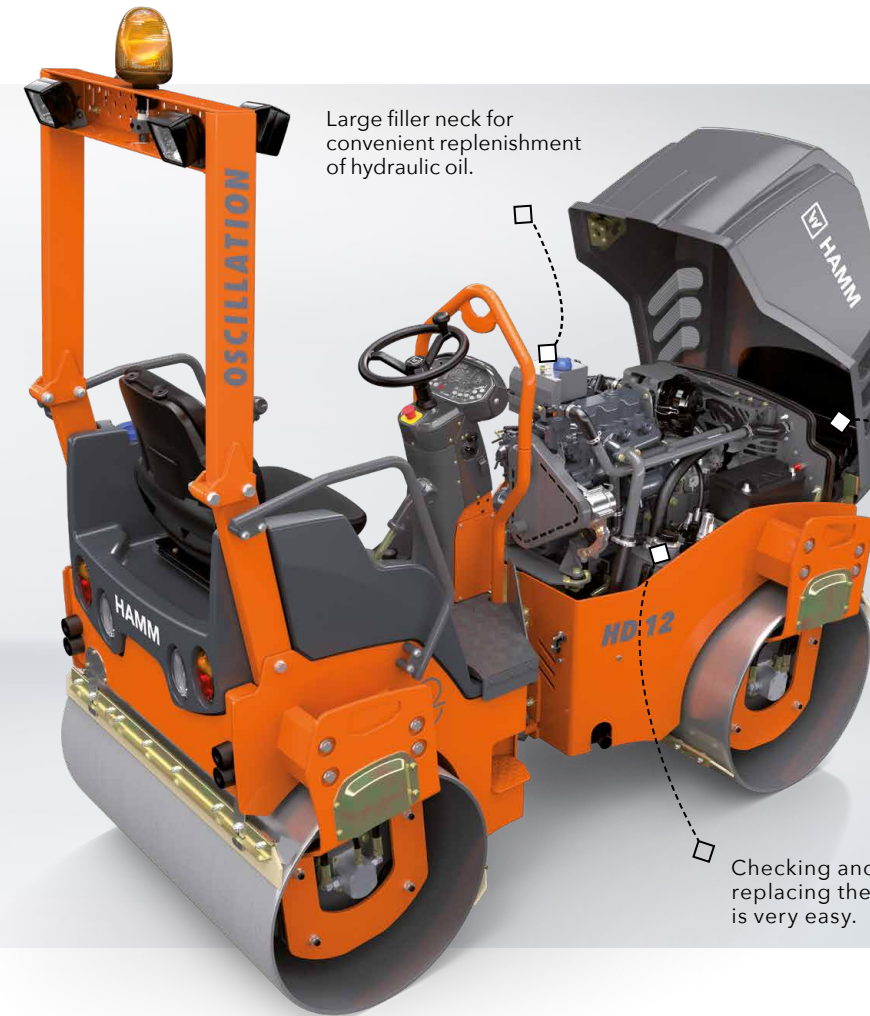
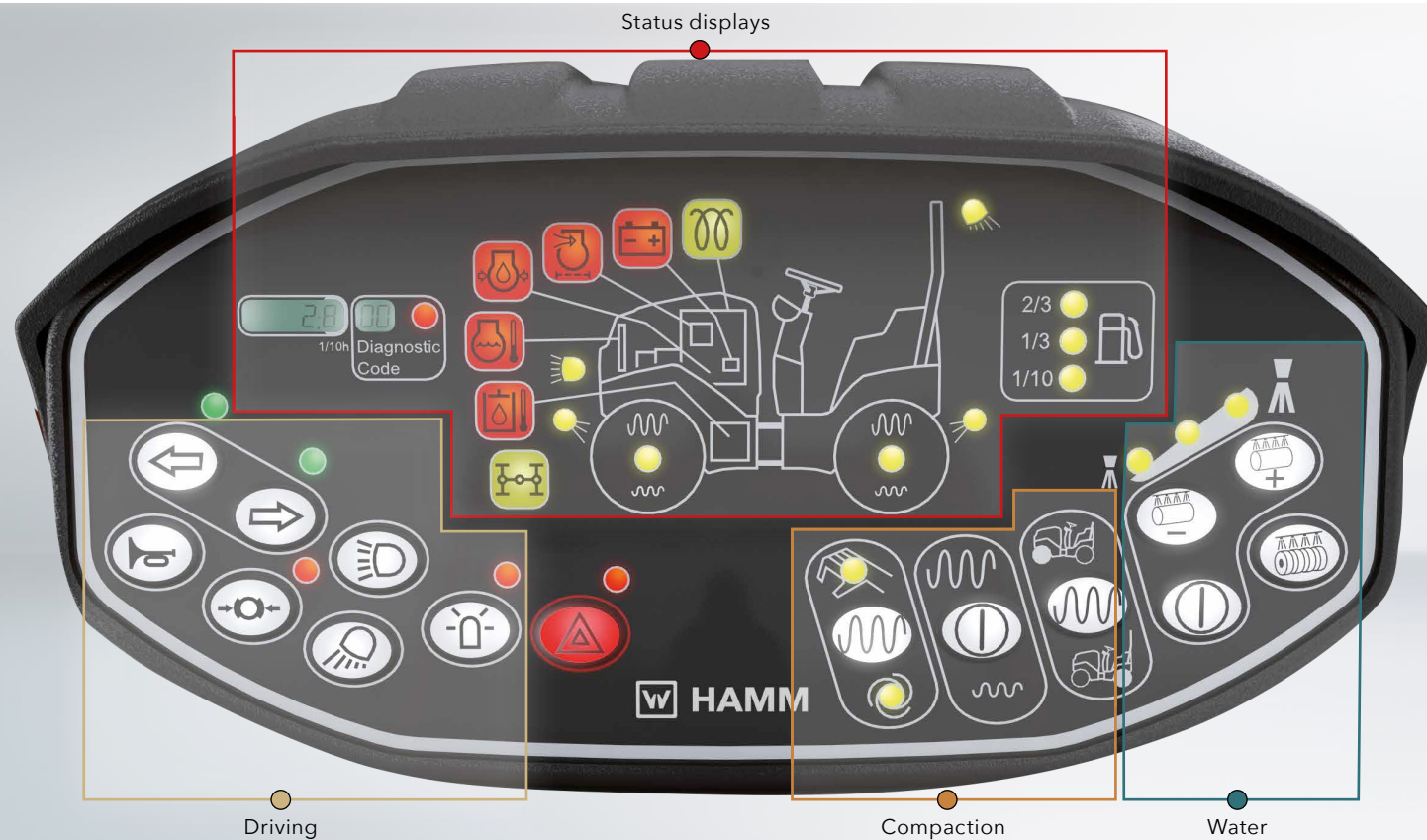

Maintenance is extremely straightforward and quick thanks to large filler necks and easily accessible maintenance items.

Ease of checking thanks to wide-opening engine hood.

Checking and replacing the filters is very easy.

## Operation - straightforward and intuitive

### Quickly learnt - no language skills required

Operation of HD CompactLine rollers is extremely easy and can be mastered in a matter of minutes. Clear marking leaves no doubt as to the functions of the operating elements. HAMM uses unambiguous symbols and colours so that operation of the rollers is immediately understandable even without language skills and drivers can achieve high-quality compaction from the outset.

### The perfect rental machine

Compact rollers are often used by a wide range of personnel. That is why the intuitive operation of HD CompactLine rollers is also important in terms of safety and economic viability. It enables safe and productive compaction right from the start. Machine rental companies, too, appreciate this advantage because HD CompactLine rollers are not only small in size and productive, but also exceptionally easy to handle.

## Maintenance - easy and fast

### Impressive water management

Checking the filters and draining the tank quickly are among the most important water-related care tasks. HAMM has smart solutions for both: the water tank outlet is located at the lowest point of the machine, beneath the driver's seat. One single manual operation is all it takes to completely drain the water tanks in the rear section. The large self-cleaning water filter located directly behind the tank cap can also be checked in a matter of seconds.

### High-speed maintenance

Daily maintenance of the HD CompactLine rollers is not only simple but can also be completed very quickly. One reason for this is that all important maintenance items on the engine and hydraulic system are located on one side. They are clearly identifiable under the wide-opening engine hood, and are readily accessible without the need for tools.

# Cabin, chip spreaders and more ...



HAMM has thought of everything. Every road construction company will find the right equipment to meet its needs in the extensive list of options.



## Cabin, chip spreaders and hinged scraper

The comfortable cabin for the HD CompactLine has full-height glazing and offers perfect visibility without intrusive pillars. It comes with a heater as standard. A radio can also be supplied as an optional extra.

In addition, HAMM offers two different chip spreaders. The precision spreaders are available in various sizes to match the operating weight and working width. The spread rate is controlled from the driver's seat and is infinitely adjustable. A special diffusion grille provides an exceptionally even distribution pattern.

The tiltable scraper cleans the drums and can be folded out of the way by means of a foot pedal. Additional guard plates block the water from the sprinkling system, preventing it spraying out sideways beyond the drum edges and thus keeping it on the drum.

## HCO modules for higher compaction quality

Quality control is becoming ever more important. This is the reason why the HD CompactLine rollers can also be equipped with the HCM (HAMM Compaction Meter) and the HTM (HAMM Temperature Meter) for measurement of the asphalt temperature. The HCM measures the rigidity of the soil or asphalt during dynamic compaction. Based on the measurement value, the driver is able to ascertain whether or not the ground requires further compaction. This minimises the number of passes and avoids over-compaction. The HTM shows the operator the current asphalt temperature. He can then decide whether to compact the asphalt dynamically or statically.

## Perfect edges - always well illuminated

The edge pressing and cutting equipment enables neat chamfering of the roadway. It can be mounted on the left, right or both sides. The corresponding pressing rolls and cutting wheels are available in many sizes and diameters. The driver can activate the water sprinkling system for the edge pressing and cutting equipment using a switch.

The powerful LED drum edge lighting provides the safety required for working in the dark, making sure that drivers can see exactly where they are compacting. This option is available for all models from 2.5 t upwards.

## Combating vandalism

Construction sites are often poorly secured overnight and at weekends. For this reason, a robust, lockable dashboard cover provides the HD CompactLine tandem rollers with effective protection against vandalism.

## Rapid loading and unloading



So that the HD CompactLine rollers are ready for action in next to no time, HAMM has also made it easy to transport them: plenty of easily accessible lashing points enable quick and secure fastening of the rollers to the transport vehicle. Unloading them on the construction site also is a breeze. A special feature of the rollers with operating weights up to 3 t is that they can be loaded and unloaded using the central lifting point on the handrail. This also allows them to be lowered into narrow trenches or structures for compacting there.





# No compromises

Maximum compaction quality for road building and landscape gardening

The HD CompactLine tandem rollers can cope with a wide range of terrains and ground conditions. They achieve the same high compaction quality for accessways and surfaces made up of non-cohesive materials such as gravel, chippings or sand and for roadbeds and carriageways in standard and special asphalts. For compacting porous asphalts, optimum results are obtained with the models weighing between 2.5 and 4 t in particular. And the oscillation rollers allow surfaces to be compacted efficiently even in sensitive environments.

HD CompactLine rollers are dependable tools in building construction as well, for example in halls or on parking levels. Thanks to their excellent climbing ability, they even master challenging tasks such as compaction on steep ramps with ease.

HAMM AG  
Hammstraße 1  
95643 Tirschenreuth - Germany  
Tel +49 9631/ 80-0  
Fax +49 9631/ 80-111  
[www.hamm.eu](http://www.hamm.eu)



**HAMM**