

Quarry Specification Excavators

ZAXIS R series

ZAXIS470R/670R/870R



HYDRAULIC EXCAVATOR

Model Code : ZX470R-5G / ZX470LCR-5G / ZX670LCR-5G / ZX870LCR-5G

Engine Rated Power : ZX470R-5G / ZX470LCR-5G : 235 kW (315 HP)

ZX670LCR-5G : 312 kW (418 HP) / ZX870LCR-5G : 360 kW (483 HP)

Operating Weight : ZX470R-5G : 46 400 kg / ZX470LCR-5G : 47 600 kg

ZX670LCR-5G : 69 300 kg / ZX870LCR-5G : 85 800 kg

Backhoe Bucket : ISO Heaped :

ZX470R-5G : 1.90 - 2.30 m³ / ZX470LCR-5G : 1.90 - 2.50 m³

ZX670LCR-5G : 2.90 - 3.30 m³ / ZX870LCR-5G : 3.50 - 4.30 m³

ZAXIS Empower your Vision.

A ZAXIS hallmark – industry-leading hydraulic technologies, and performance no other can beat. New ZAXIS provides reliable solutions: impressive fuel economy, swift front movements, and easy operation. You'll also find Hitachi technological prowess and expertise, such as the optimized hydraulic system and engine. New ZAXIS features the key benefits of high quality, low fuel consumption, and high durability, all of which serve to ensure low running costs. New ZAXIS, which is empowered by comprehensive evolution, will realize customers' visions and dreams, and pioneer your colorful future.

Key Benefits for Low Running Costs

- High Quality
- Low Fuel Consumption
- High Durability



Model : ZAXIS 470LCR

Pursuits of Performance and Durability Powerful in Quarry

Page 4-5

- The required strength and durability for customer satisfaction
- Prestige R&D and quality control
- R-bucket
- Specially designed front attachment for quarry
- Tougher undercarriage for rocky ground condition

No Compromise on Operator Comfort

Page 8

- Comfortable operating environment
- Comfort-designed operator seat
- H/R cab
- New, easy-to-use multifunction monitor

Large Production with Less Fuel

Page 6-7

- Reduction in fuel consumption
- Durable, reliable engine
- Swift front movements with HIOS IIIB hydraulics
- Enhancement in swing torque
- Easy-to use attachments
- Applicable for breaker operation (Optional)

Simplified Maintenance

Page 9

- Useful inspection points
- Fast lubrication
- Easy-access to the upperstructure

Hitachi Support Chain

Page 10-11

- Remote fleet management with Global e-Service
- Parts and service



Model : ZAXIS 470LCR

Pursuits of Performance and Durability Powerful in Quarry

The Required Strength and Durability for Customer Satisfaction

- **Beating the competition with exclusive design for quarries and limestone mines using a wealth of experience**
- **Increasing durability by strengthening the undercarriage, boom and arm on the H-specification machine**
- **Buckets are exclusively developed and built for quarries and limestone**
- **H/R cab provided with fixed front straight-laminated glass window**

Prestige R&D and Quality Control

Hitachi has earned praise for technological prowess and product performance around the world. R&D Division has a track record – including excellent design, stress analysis expertise using CAE system, and abundant production database. What's more, a large-scale durability test field (427 hm²) allows for a series of stringent testing of new machines. Production Division strives to automatize production processes, including robotic welding, machining, painting, assembling and transferring.

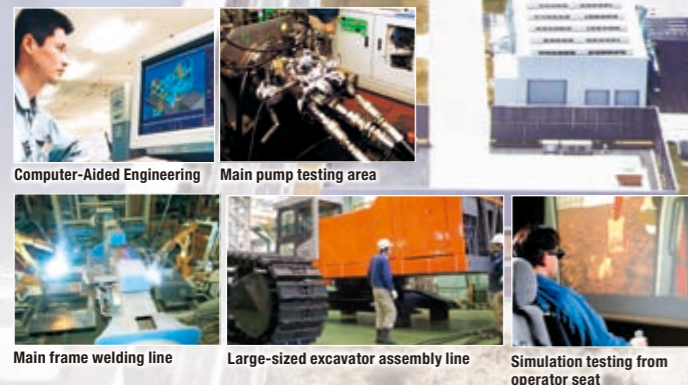

Specially Designed Front Attachment for Quarry

The boom-end rigidity through the use of a thick single plate and increased boomend bushing thickness also contribute increasing durability. Reinforced arm-end boss and arm cylinder mounting bracket provides higher durability. Protection plate with 5-square bars also enhances reliability in heavy duty operation.

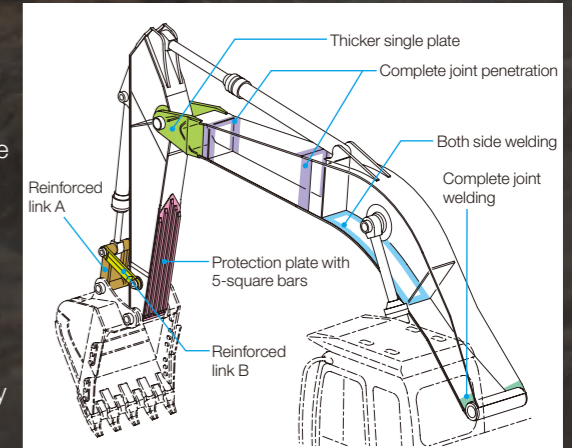

R-Bucket

The R-bucket is made of wear resisting steel, and reshaped with side shrouds, cutting-edge shrouds, and large bucket teeth for enhanced durability. Easily replaceable lateral wear plates help reduce downtime. The limestone bucket has similar features except number of side shrouds and size of tooth.

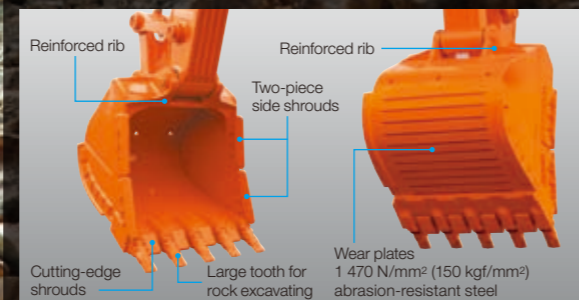

Tougher Undercarriage for Rocky Ground Condition

The reinforced travel motor cover with square bars and reinforced travel guard protect travel motor from damage by stone projectiles. Rigid structure of side frame withstands frequent shock caused by rock hitting. Track under cover (Optional) protects travel pipings and hoses. Full track guards protect track links and lower rollers from damage and deformation. Moreover, they also keep out stones, preventing overload to the undercarriage to reduce wear and damage.



Photos and illustration show ZAXIS 870LCR.

How to strengthen bucket, boom, arm and undercarriage according to the model.

Large Production with Less Fuel

Reduction in Fuel Consumption

New ZAXIS is a fuel-thrifty excavator that can reduce fuel consumption. Thanks to the HIOS III B hydraulic system and engine control system, thereby reducing CO2 emissions.

- ZX470R-5G / ZX470LCR-5G : 9%*
- ZX670LCR-5G : 6%*
- ZX870LCR-5G : 4%*

*H/P mode vs. conventional model's H/P mode.

Durable, Reliable Engine

This engine has a track record showing impressive durability at countless tough job sites around the world.

The engine — associated with a rugged design, a direct fuel injection system and an elaborate governor — goes green, and complies with EU Stage II and US EPA Tier 2 emissions regulations.

The combination of a engine and the new HIOS III B hydraulic system meets requirements, in terms of both output and fuel consumption.



ZAXIS 470R / 470LCR



ZAXIS 670LCR / 870LCR

Swift Front Movements with HIOS* IIB Hydraulics

Operating speed increases with less fuel consumption thanks to the HIOS III B hydraulic system, developed by industry-leading hydraulic technologies and a wealth of experience.

*Human & Intelligent Operation System.

Improved Arm Controllability

Improved arm controllability for level luffing and level crowding for front movements, including swing operations. The boom regenerative circuit using, the boom weight and the newly adopted variable orifice of the swing circuit, help ensure hydraulic oil can be effectively allocated and pressure loss can be reduced.



Model : ZAXIS 870LCR

Enhancement in Swing Torque

One of the key performance requirements for mining machinery is swing power. It must be capable of holding and swinging buckets full of crushed stones powerfully, and then loading them onto a dump truck. The new ZAXIS adopts a newly developed swing device to improve swing power by 9%* over conventional models. It also has sufficient capacity to load crushed stones onto a dump truck.

- ZX470R-5G / ZX470LCR-5G : 8%*
- ZX670LCR-5G : 9%*
- ZX870LCR-5G : 9%*

*Compared to the conventional model.

Easy-to-Use Attachments

The operator can change over valves (ZAXIS 470 family only), adjust extra circuit flow and check settings from the multifunction monitor next to the operator seat.

What's more, 11 jobs, including flow rate setting, can easily be selected by their identified names.



Breaker settings

Model : ZAXIS 870LCR

Applicable for Breaker Operation (Optional)

Double Accumulator

Double accumulator protects hydraulic pumps from pulse beat from breaker.



Hour Meter for the Breaker

With the new ZAXIS, the number of hours that the breaker has been used for can be displayed on the multi function monitor. In addition, since the breaker operation hours and working ratio can be viewed, the operator can verify the time when the hydraulic oil and filter should be replaced. (with resettable trip function)

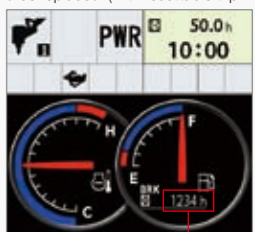

Breaker hour meter

Ergonomic Breaker Pedal Layout



Shatterproof Windshield and Window

Laminated film on the front windshield and right side window to prevent shattering.



No Compromise on Operator Comfort



Control panel

Large storage space



The photo shows an optional air suspension seat.

Comfortable Operating Environment

You'll feel comfortable and confident, with plenty of leg space and excellent visibility. The new compact console gives more leg space. The new door pillar is shifted rearward by 70 mm to widen an entry space for easy access. A new LED room light, interlocked with the door, turns on when the door opens. Ample air conditioner vents are located strategically for uniform air circulation inside the cab. The control panel and control levers are arranged within easy reach of the operator. AUX port (Optional) for a mobile music player are available for a long work day with less fatigue. All these designs focus on operator comfort.

Comfort-Designed Operator Seat

The luxury cloth seat is fitted with a headrest and arm rests for operator comfort. The seat can be adjusted in multiple ways, sliding and reclining, to suit operator's size and preferences. The seat can slide rearward by 40 mm more for added leg space. An air suspension with a heat pad is optional.

H/R Cab

The H/R cab, meeting the OPG (Top Guard Level II), protects the operator from falling objects. The pilot control shut-off lever is provided with the neutral engine start system that permits engine starting only when the pilot control shut-off lever is in Lock position. The engine is lockable by entering a password through the 10-key panel.



*Front guard (upper and lower) is optional.

Simplified Maintenance



Air cleaner

An air conditioner filter for fresh air



Useful Inspection Points

Inspection points with three models, which are arranged according to the machine layout. A lid behind the cab door is available for easy replacement of the air conditioner filters for fresh air.

Fast Lubrication

The arm and boom have their own centralized greasing points for fast lubrication. An optional electric grease gun with hose-reel or an auto-grease lubricator is also available for faster greasing / lubrication.

Easy-Access to the Upperstructure

A large sidewalk is provided on the left side of the cab, making it easy to access the engine and inspection points. Anti-slip steps and handrail are provided for safety.



Inspection points on the right cover

Inspection points on the left cover



Sidewalk



Centralized boom and arm greasing points

Electric grease gun with hose-reel (Optional)

Photos show ZAXIS 470R series.

New, Easy-to-Use Multifunction Monitor

The new multi-language, multifunction monitoring system comprises of a 7-inch high-resolution color monitor and a multifunction controller. The monitor allows the operator to check varying operating variables: hydraulic oil temperature, fuel level, work mode, full-auto air conditioner, AM/FM radio, rear view monitor camera (Optional), maintenance support, and attachment flow adjustment. Menu items can be selected and adjusted by a multifunction controller on the control panel. A new rear view monitor camera always displays the view behind the machine.

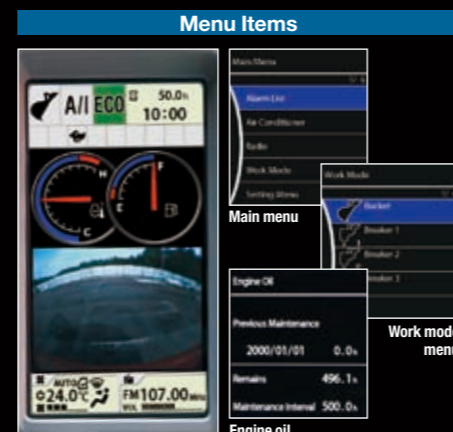

Menu Items

Main menu

Work mode menu



Hitachi Support Chain

Hitachi Support Chain is a full customer support system offered after buying a Hitachi machine.

Remote Fleet Management with Global e-Service

Easy Access to On-Site Machines through the Internet

This on-line fleet management system allows you to access each on-site machine from a PC in your office. You can get its operating information and location to increase productivity of the fleet and reduce downtime. Operating data and log are sent to a Hitachi server for processing, and then to customer and dealers around the world. This system is available 24 hours a day, all the year around.

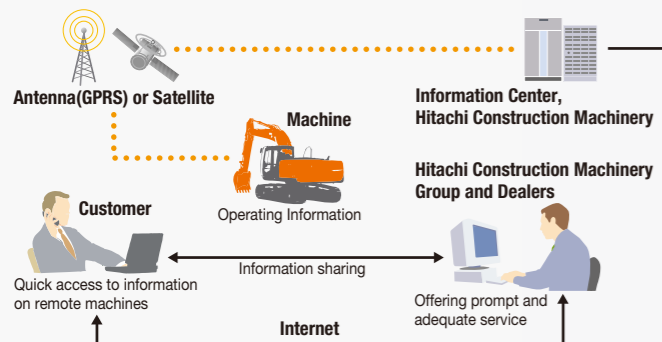

Note: In Some Regions, Global e-Service Is Not Available by Local Regulations.

Main Features of Global e-Service

Functions

Global e-Service provides easy access to a machine on site, conveying operating information and log, including daily operating hours, fuel level, temperatures, pressures, and the likes.

Maintenance

Maintenance data and log are displayed on a easy-to-read monitor screen, suggesting recommended maintenance for efficient fleet management.

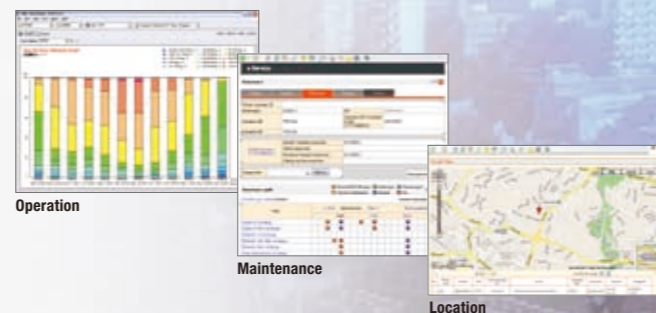

Parts and Service

Hitachi full customer support is available every area on the globe for full customer satisfaction through Hitachi local dealers.

Parts

Hitachi Global Online Network, a parts supply system, is linked with Japan Parts Center, overseas depots and over 150 dealers abroad to deliver on-line parts information, including in-stock parts, order receptions, shipments and delivery period of over one million parts and components.

Genuine Hitachi Parts

Genuine Hitachi parts, meeting Hitachi stringent quality standards, are guaranteed according to Hitachi warranty standards. The use of genuine Hitachi parts, including engine, fuel, hydraulic oil and filters, may slash running costs, and extend machine life.

Ground Engaging Tools (GETs)

Hitachi provides an array of Hitachi Ground Engaging Tools developed and built for a variety of applications.

Using high-quality, well-maintained GETs will help you get customers' trust.

Note: Some dealers do not handle Hitachi GETs.

Remanufactured Components

Hitachi components are remanufactured according to the stringent remanufacturing standards at four factories around the world. They have high quality equivalent to new ones, and backed up by Hitachi warranty system.

Note: Some dealers do not handle Hitachi Remanufactured Components.

Service

Extended Warranty – HELP

Hitachi Standard Warranty System is available on all new Hitachi machines. In addition, Hitachi offers Hitachi Extended Life Programs (HELPS) to suit customer expectations –

protecting machines under tough operating conditions, avoiding unexpected downtime, and reducing repair costs.

Note: Warranty conditions vary by equipment.

Diagnostic Tools – Maintenance Pro

Electronic control system needs quick on-site solutions, apart from mechanical repairs. Hitachi's Maintenance Pro can diagnose machine failures in a short time by plugging a PC into a failed machine.

Technical Training

On-site servicing matters despite locations to keep the machine at peak performance and reduce downtime. Technical Training Center (TTC), located in Japan, educates and trains service technicians and service support personnel coming from Hitachi dealers and factories on the globe according to the international training programs.

SPECIFICATIONS

| ENGINE | | | |
|---------------------|--|--|--|
| | ZX470R-5G / ZX470LCR-5G | ZX670LCR-5G | ZX870LCR-5G |
| Model | Isuzu AA-6WG1TQA | Isuzu BB-6WG1XQA-05 | Isuzu BB-6WG1XQA-04 |
| Type | 4-cycle water-cooled, direct injection | | |
| Aspiration | Turbocharged | Turbocharged, intercooled | |
| No. of cylinders | 6 | | |
| Rated power | | | |
| ISO 14396 | H/P mode: 235 kW / 1 800 min ⁻¹ (315 HP / 1 800 rpm) | H/P mode: 312 kW / 1 800 min ⁻¹ (418 HP / 1 800 rpm) | H/P mode: 360 kW / 1 800 min ⁻¹ (483 HP / 1 800 rpm) |
| Maximum torque | 1 275 Nm / 1 500 min ⁻¹ (130 kgf m / 1 500 rpm) | 1 621 Nm / 1 500 min ⁻¹ (165 kgf m / 1 500 rpm) | 1 945 Nm / 1 500 min ⁻¹ (198 kgf m / 1 500 rpm) |
| Piston displacement | 15.681 L | 15.681 L | 15.681 L |
| Bore and stroke | 147 mm x 154 mm | 147 mm x 154 mm | 147 mm x 154 mm |
| Batteries | 2 x 12 V / 170 Ah | 2 x 12 V / 170 Ah | 2 x 12 V / 170 Ah |

| HYDRAULIC SYSTEM | | | |
|------------------------------|--|--|--|
| | ZX470R-5G / ZX470LCR-5G | ZX670LCR-5G | ZX870LCR-5G |
| Hydraulic Pumps | | | |
| Main pumps | 2 variable displacement axial piston pumps | | |
| Maximum oil flow | 2 x 360 L/min | 2 x 443 L/min | 2 x 512 L/min |
| Pilot pump | 1 gear pump | | |
| Maximum oil flow | 30 L/min | 50 L/min | 50 L/min |
| Hydraulic Motors | | | |
| Travel | 2 axial piston motors with parking brake | | |
| Swing | 2 axial piston motors | | |
| Relief Valve Settings | | | |
| Implement circuit | 31.9 MPa (325 kgf/cm ²) | 31.9 MPa (325 kgf/cm ²) | 31.9 MPa (325 kgf/cm ²) |
| Swing circuit | 28.4 MPa (290 kgf/cm ²) | 29.4 MPa (300 kgf/cm ²) | 28.4 MPa (290 kgf/cm ²) |
| Travel circuit | 35.3 MPa (360 kgf/cm ²) | 34.3 MPa (350 kgf/cm ²) | 34.3 MPa (350 kgf/cm ²) |
| Pilot circuit | 3.9 MPa (40 kgf/cm ²) | 3.9 MPa (40 kgf/cm ²) | 3.9 MPa (40 kgf/cm ²) |
| Power boost | 35.3 MPa (360 kgf/cm ²) | 34.3 MPa (350 kgf/cm ²) | 34.3 MPa (350 kgf/cm ²) |

| Hydraulic Cylinders | | | | | | | | | |
|---------------------|-------------------------|--------|--------------|-------------|--------|--------------|-------------|--------|--------------|
| | ZX470R-5G / ZX470LCR-5G | | | ZX670LCR-5G | | | ZX870LCR-5G | | |
| | Quantity | Bore | Rod diameter | Quantity | Bore | Rod diameter | Quantity | Bore | Rod diameter |
| Boom | 2 | 170 mm | 115 mm | 2 | 190 mm | 130 mm | 2 | 215 mm | 150 mm |
| Arm | 1 | 190 mm | 130 mm | 1 | 200 mm | 140 mm | 1 | 225 mm | 160 mm |
| Bucket | 1 | 170 mm | 120 mm | 1 | 180 mm | 130 mm | 1 | 200 mm | 140 mm |
| Bucket BE | - | - | - | 1 | 190 mm | 130 mm | 1 | 215 mm | 150 mm |

| UPPERSTRUCTURE | | | |
|--------------------------|--|-----------------------------|-----------------------------|
| | ZX470R-5G / ZX470LCR-5G | ZX670LCR-5G | ZX870LCR-5G |
| Revolving frame | D-section frame for resistance to deformation. | | |
| Swing device | Axial piston motor with planetary reduction gear is bathed in oil. Swing parking brake is spring-set/hydraulic-released disc type. | | |
| Swing speed | 9.0 min ⁻¹ (rpm) | 9.0 min ⁻¹ (rpm) | 7.4 min ⁻¹ (rpm) |
| Operator's cab (H/R cab) | Independent spacious cab, 1 025 mm wide by 1 817 mm high, The OPG top guard fitted Level II conforms to the related requirements of the International Organization Standardization(ISO)10262. | | |

| UNDERCARRIAGE | | | |
|---------------|---|-------------|-------------|
| | ZX470R-5G / ZX470LCR-5G | ZX670LCR-5G | ZX870LCR-5G |
| Tracks | Track shoes made of induction-hardened rolled alloy. Heat-treated connecting pins with dirt seals. Hydraulic (grease) track adjusters with shock-absorbing recoil springs. Fitted with reinforced travel motor cover and idler part of side frame. | | |

Numbers of Rollers and Shoes on Each Side

| | | | |
|------------------------|---|--|--|
| Upper rollers | 2 | 3 | 3 |
| Lower rollers | 8 / 9 | 8 | 9 |
| Track shoes | 49 / 53 | 47 | 51 |
| Full track guard | 1 | 1 | 1 |
| Travel device | Each track driven by axial piston motor through reduction gear for counterrotation of the tracks. Parking brake is spring-set/hydraulic-released disc type. Automatic transmission system: High-Low. The travel motor cover is reinforced with square bar for protection. | | |
| Travel speeds | High / Low : 0 to 5.1 / 0 to 3.8 km/h | High / Low : 0 to 4.8 / 0 to 3.3 km/h | High / Low : 0 to 4.5 / 0 to 3.0 km/h |
| Maximum traction force | 329 kN (33 600 kgf) | 460 kN (46 900 kgf) | 560 kN (57 100 kgf) |
| Gradeability | 70% (35 degree) continuous | | |

| SERVICE REFILL CAPACITIES | | | |
|---------------------------|-------------------------|-------------|-------------|
| | ZX470R-5G / ZX470LCR-5G | ZX670LCR-5G | ZX870LCR-5G |
| Fuel tank | 705.0 L | 920.0 L | 1 110.0 L |
| Engine coolant | 61.0 L | 68.0 L | 112.0 L |
| Engine oil | 52.0 L | 52.0 L | 52.0 L |
| Pump device | - | 6.2 L | 6.2 L |
| Swing device (each side) | 6.5 L | 10.5 L | 15.7 L |
| Travel device (each side) | 11.0 L | 16.0 L | 19.0 L |
| Hydraulic system | 510.0 L | 750.0 L | 1 042.0 L |
| Hydraulic oil tank | 310.0 L | 380.0 L | 500.0 L |

SPECIFICATIONS

WEIGHTS AND GROUND PRESSURE

Operating Weight and Ground Pressure

ZX470R-5G / ZX470LCR-5G

| Shoe type | Shoe width | Boom type | Arm type | ZX470R-5G | | ZX470LCR-5G | |
|-----------|------------|-----------------|-----------|---------------------|----------------------------|---------------------|----------------------------|
| | | | | kg | kPa (kgf/cm ²) | kg | kPa (kgf/cm ²) |
| Triple | 600 mm | 7.0 m R | 3.4 m R | 46 400 | 86 (0.88) | 47 600 | 81 (0.82) |
| | | Bucket capacity | | 1.90 m ³ | | 1.90 m ³ | |
| | | 7.0 m R | 2.9 m BER | 46 400 | 86 (0.88) | 47 500 | 81 (0.82) |
| | | Bucket capacity | | 2.10 m ³ | | 2.10 m ³ | |
| | | 6.3 m BER | 2.9 m BER | 46 300 | 86 (0.88) | 47 600 | 81 (0.82) |
| | | Bucket capacity | | 2.10 m ³ | | 2.30 m ³ | |
| | | 6.3 m BER | 2.5 m BER | 47 100 | 81 (0.83) | 48 400 | 81 (0.83) |
| | | Bucket capacity | | 2.30 m ³ | | 2.50 m ³ | |

ZX670LCR-5G

| Shoe type | Shoe width | Boom type | Arm type | kg | kPa (kgf/cm ²) |
|-----------|------------|-----------------|-----------|---------------------|----------------------------|
| Double | 650 mm | 7.8 m R | 3.6 m R | 69 300 | 104 (1.06) |
| | | Bucket capacity | | 2.90 m ³ | |
| | | 6.8 m BER | 2.9 m BER | 69 200 | 104 (1.06) |
| | | Bucket capacity | | 3.30 m ³ | |

ZX870LCR-5G

| Shoe type | Shoe width | Boom type | Arm type | kg | kPa (kgf/cm ²) |
|-----------|------------|-----------------|------------|---------------------|----------------------------|
| Double | 650 mm | 8.4 m R | 3.7 m R | 85 800 | 117 (1.19) |
| | | Bucket capacity | | 3.50 m ³ | |
| | | 7.1 m BER | 3.7 m BER | 85 300 | 116 (1.18) |
| | | Bucket capacity | | 3.70 m ³ | |
| | | 7.1 m BER | 2.95 m BER | 86 200 | 117 (1.20) |
| | | Bucket capacity | | 4.30 m ³ | |

BUCKET LIST

ZX470R-5G / ZX470LCR-5G

| Capacity | Width | | No. of teeth | Weight | Recommendation | | | |
|---------------------|----------------------|-------------------|--------------|---------------|-------------------------|---------------|--------------|-------|
| | | | | | ZX470R-5G / ZX470LCR-5G | | | |
| | | | | | 6.3 m BER-boom | | 7.0 m R-boom | |
| ISO heaped | Without side cutters | With side cutters | | 2.5 m BER-arm | 2.9 m BER-arm | 2.9 m BER-arm | 3.4 m R-arm | |
| 1.90 m ³ | 1 480 mm | 1 500 mm | 5 | 2 070 kg | ● / ● | ● / ● | ● / ● | ● / ● |
| 2.10 m ³ | 1 560 mm | 1 580 mm | 5 | 2 170 kg | ● / ● | ● / ● | ● / ● | - / - |
| 2.30 m ³ | 1 680 mm | 1 700 mm | 5 | 2 260 kg | ● / ● | - / ● | - / - | - / - |
| 2.50 m ³ | 1 800 mm | 1 820 mm | 5 | 2 360 kg | - / ● | - / - | - / - | - / - |

ZX670LCR-5G

| Capacity | Width | | No. of teeth | Weight | Recommendation | |
|---------------------|----------|----------|--------------|----------|----------------|--------------|
| | | | | | 6.8 m R-boom | 7.8 m R-boom |
| | | | | | 2.9 m BER-arm | 3.6 m R-arm |
| 2.90 m ³ | 1 680 mm | 1 680 mm | 5 | 3 300 kg | x | ● |
| 3.30 m ³ | 1 790 mm | 1 790 mm | 5 | 3 610 kg | ● | x |

ZX870LCR-5G

| Capacity | Width | | No. of teeth | Weight | Recommendation | | |
|---------------------|----------|----------|--------------|----------|----------------|-------------|--------------|
| | | | | | 7.1 m BER-boom | | 8.4 m R-boom |
| | | | | | 2.95 m BER-arm | 3.7 m R-arm | 3.7 m R-arm |
| 3.50 m ³ | 1 870 mm | 1 890 mm | 5 | 4 870 kg | x | ● | ● |
| 3.70 m ³ | 1 950 mm | 1 970 mm | 5 | 4 970 kg | x | ● | x |
| 4.30 m ³ | 2 090 mm | 2 110 mm | 5 | 5 690 kg | ● | x | x |

● R-bucket x Can't be installed - Not applicable

BUCKET AND ARM DIGGING FORCE

ZX470R-5G / ZX470LCR-5G

| | ZX470R-5G | | ZX470LCR-5G | | | |
|---------------------------|---------------------|---------------------|---------------------|---------------------|---------------------|---------------------|
| | 7.0 m R-boom | | 6.3 m BER-boom | | 7.0 m R-boom | |
| | 2.9 m BER-arm | 3.4 m R-arm | 2.5 m BER-arm | 2.9 m BER-arm | 2.9 m BER-arm | 3.4 m R-arm |
| Bucket digging force* ISO | 295 kN (30 150 kgf) | 296 kN (30 260 kgf) | 295 kN (30 150 kgf) | 295 kN (30 150 kgf) | 295 kN (30 150 kgf) | 296 kN (30 260 kgf) |
| Bucket digging force* SAE | 266 kN (27 070 kgf) | 257 kN (26 240 kgf) | 266 kN (27 070 kgf) | 266 kN (27 070 kgf) | 266 kN (27 070 kgf) | 257 kN (26 240 kgf) |
| Arm crowd force* ISO | 263 kN (26 860 kgf) | 224 kN (22 850 kgf) | 302 kN (30 770 kgf) | 263 kN (26 860 kgf) | 263 kN (26 860 kgf) | 224 kN (22 850 kgf) |
| Arm crowd force* SAE | 256 kN (26 140 kgf) | 215 kN (21 920 kgf) | 294 kN (30 050 kgf) | 256 kN (26 140 kgf) | 256 kN (26 140 kgf) | 215 kN (21 920 kgf) |

ZX670LCR-5G

| | 6.8 m BER-boom | 7.8 m R-boom |
|---------------------------|---------------------|---------------------|
| Arm length | 2.9 m BER-arm | 3.6 m R-arm |
| Bucket digging force* ISO | 369 kN (37 700 kgf) | 324 kN (33 100 kgf) |
| Bucket digging force* SAE | 332 kN (33 900 kgf) | 286 kN (29 200 kgf) |
| Arm crowd force* ISO | 306 kN (31 200 kgf) | 255 kN (26 000 kgf) |
| Arm crowd force* SAE | 297 kN (30 300 kgf) | 246 kN (25 100 kgf) |

ZX870LCR-5G

| | 7.1 m BE-boom | | 8.4 m R-boom |
|---------------------------|---------------------|---------------------|---------------------|
| Arm length | 2.95 m BER-arm | 3.7 m R-arm | 3.7 m R-arm |
| Bucket digging force* ISO | 472 kN (48 200 kgf) | 402 kN (41 000 kgf) | 402 kN (41 000 kgf) |
| Bucket digging force* SAE | 411 kN (41 900 kgf) | 359 kN (36 600 kgf) | 359 kN (36 600 kgf) |
| Arm crowd force* ISO | 394 kN (40 200 kgf) | 324 kN (33 100 kgf) | 324 kN (33 100 kgf) |
| Arm crowd force* SAE | 378 kN (38 600 kgf) | 316 kN (32 200 kgf) | 316 kN (32 200 kgf) |

* At power boost

SPECIFICATIONS

DIMENSIONS

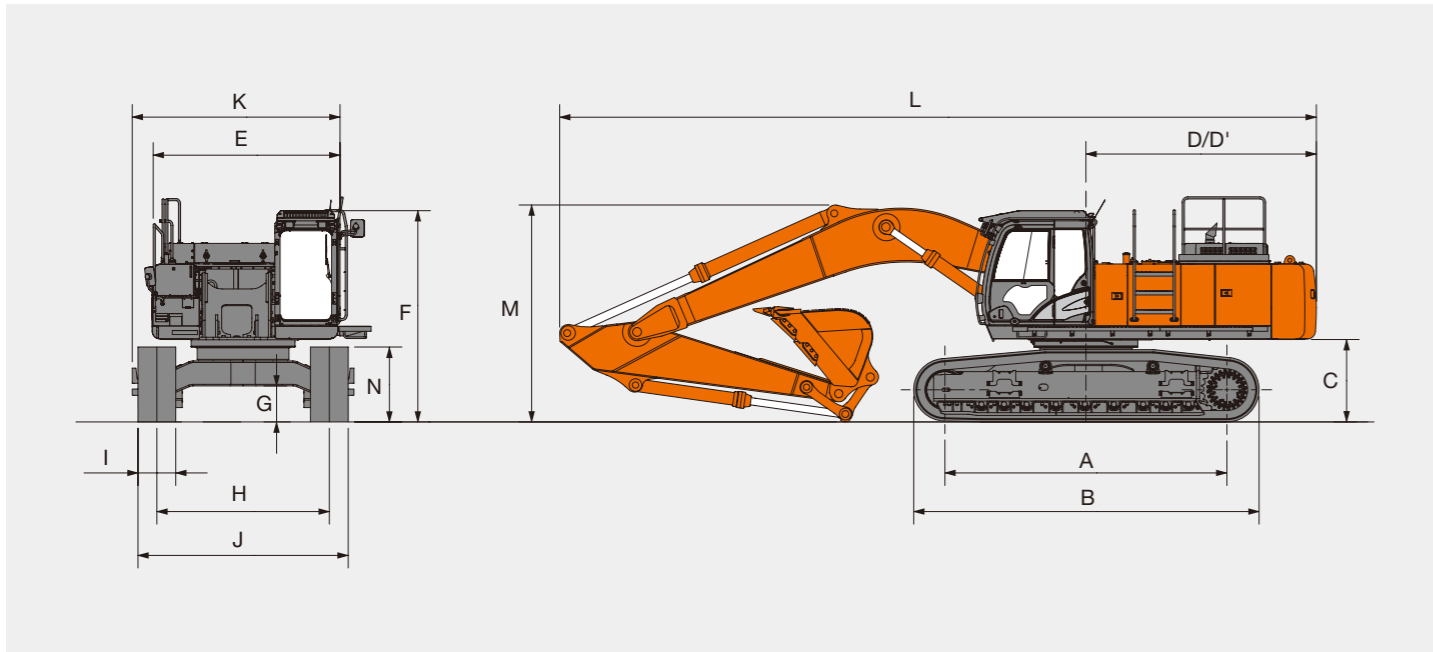

The illustration is shown ZX470LCR-5G

Unit: mm

| Retractable gauge | ZX470R-5G | ZX470LCR-5G | ZX670LCR-5G | ZX870LCR-5G |
|---|-----------|-------------|---------------|---------------|
| A Distance between tumbler | 4 040 | 4 470 | 4 590 | 5 110 |
| B Undercarriage length | 5 040 | 5 470 | 5 840 | 6 360 |
| *1 C Counterweight clearance | 1 230 | 1 270 | 1 530 | 1 680 |
| D Rear-end swing radius | 3 670 | 3 670 | 4 020 | 4 600 |
| D' Rear-end length | 3 660 | 3 660 | 3 910 | 4 520 |
| E Overall width upperstructure | 3 480 | 3 480 | 4 090 | 4 120 |
| F Overall height of cab | 3 280 | 3 320 | 3 660 | 3 800 |
| *1 G Min. ground clearance | 495 | 535 | 860 | 890 |
| H Track gauge: Extended / Retracted | 2 740 | 2 740 | 3 300 / 2 830 | 3 450 / 2 830 |
| I Track shoe width | 600 | 600 | 650 | 650 |
| J Undercarriage width with 600 mm shoe | 3 340 | 3 340 | - | - |
| : Extended / Retracted with 650 mm shoe | - | - | 3 950 / 3 480 | 4 100 / 3 480 |
| K Overall width | 3 820 | 3 820 | 4 360 | 4 450 |
| L Overall length | 12 040 | 12 040 | 13 400 | 14 800 |
| M Overall height of boom | 3 740 | 4 120 | 4 460 | 4 770 |
| N Track height | 1 150 | 1 150 | 1 440 | 1 500 |

*1 Excluding track shoe lug

WORKING RANGES

ZX470R-5G / ZX470LCR-5G

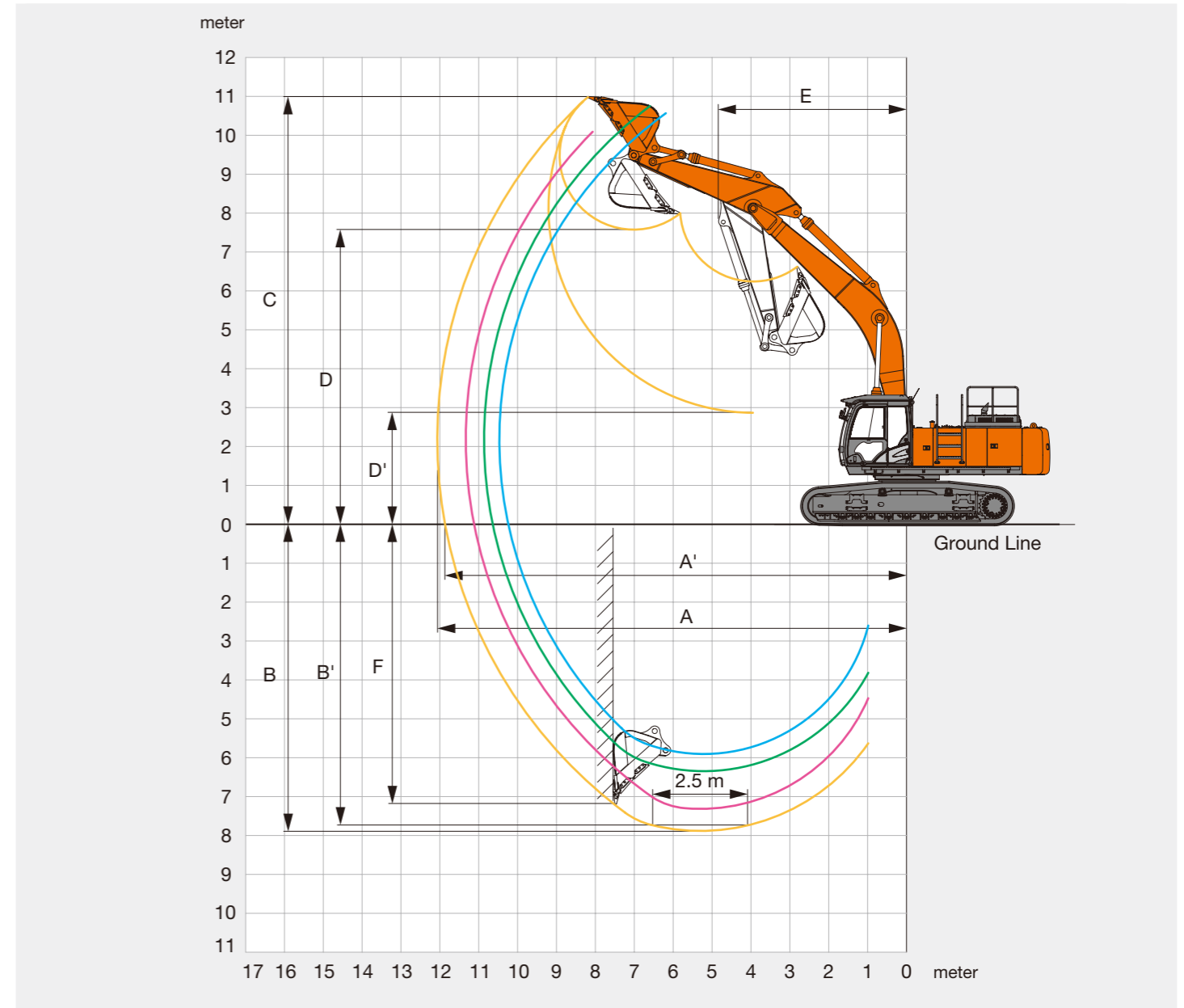

Unit: mm

| | ZX470R-5G | | ZX470LCR-5G | | | |
|---|---------------|-------------|----------------|---------------|---------------|-------------|
| | 7.0 m R-boom | | 6.3 m BER-boom | | 7.0 m R-boom | |
| | 2.9 m BER-arm | 3.4 m R-arm | 2.5 m BER-arm | 2.9 m BER-arm | 2.9 m BER-arm | 3.4 m R-arm |
| A Max. digging reach | 11 330 | 12 060 | 10 460 | 10 750 | 11 330 | 12 060 |
| A' Max. digging reach (on ground) | 11 120 | 11 860 | 10 230 | 10 630 | 11 110 | 11 860 |
| B Max. digging depth | 7 330 | 7 900 | 5 880 | 6 220 | 7 290 | 7 860 |
| B' Max. digging depth (for 2.5 m level) | 7 130 | 7 760 | 5 710 | 6 060 | 7 090 | 7 720 |
| C Max. cutting height | 10 040 | 10 920 | 10 570 | 10 700 | 10 080 | 10 980 |
| D Max. dumping height | 6 970 | 7 520 | 7 230 | 7 350 | 7 010 | 7 560 |
| D' Min. dumping height | 3 390 | 2 810 | 3 580 | 3 160 | 3 430 | 2 850 |
| E Min. swing radius | 5 020 | 4 840 | 4 090 | 3 930 | 5 020 | 4 840 |
| F Max. vertical wall | 4 400 | 7 230 | 4 350 | 4 740 | 4 360 | 7 190 |

Excluding track shoe lug

SPECIFICATIONS

WORKING RANGES

ZX670LCR-5G

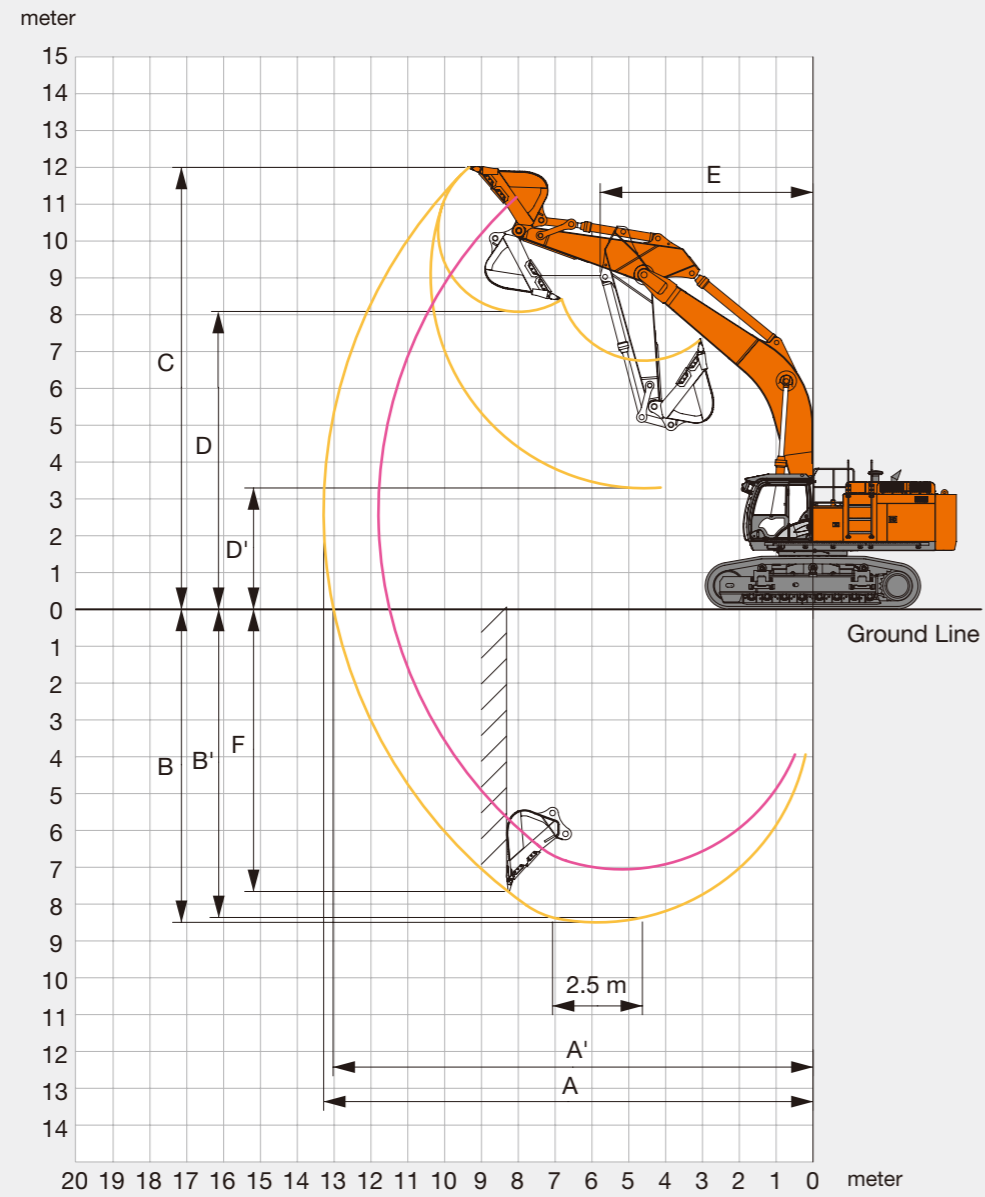

Unit: mm

| | ZX670LCR-5G | |
|---|----------------|--------------|
| | 6.8 m BER-boom | 7.8 m R-boom |
| | 2.9 m BER-arm | 3.6 m R-arm |
| A Max. digging reach | 11 800 | 13 280 |
| A' Max. digging reach (on ground) | 11 500 | 13 030 |
| B Max. digging depth | 7 120 | 8 560 |
| B' Max. digging depth (for 2.5 m level) | 6 970 | 8 420 |
| C Max. cutting height | 11 190 | 11 940 |
| D Max. dumping height | 7 330 | 8 020 |
| D' Min. dumping height | 3 200 | 3 230 |
| E Min. swing radius | 5 240 | 5 780 |
| F Max. vertical wall | 5 280 | 7 720 |

Excluding track shoe lug

WORKING RANGES

ZX870LCR-5G

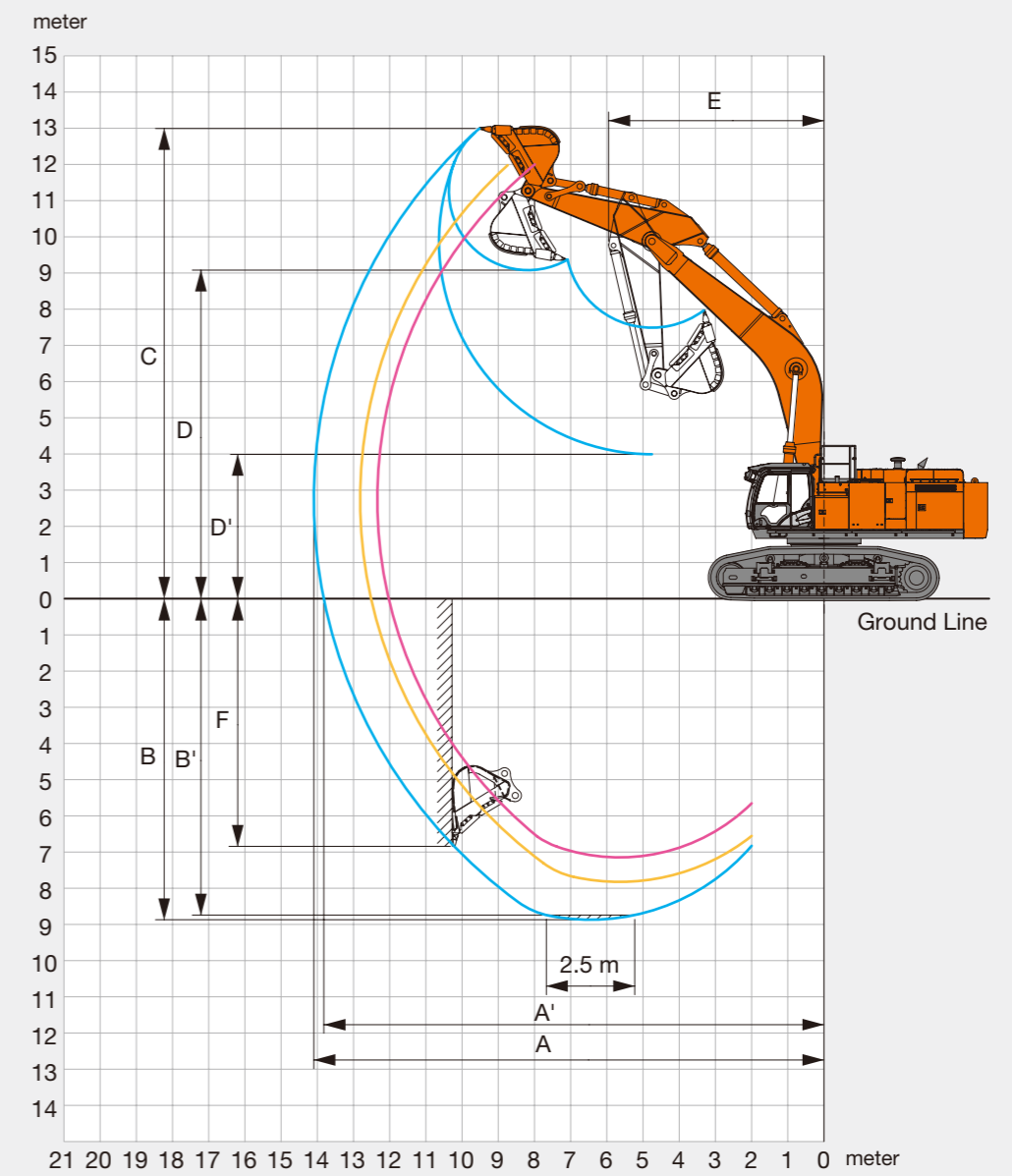

Unit: mm

| | ZX870LCR-5G | | |
|---|----------------|-------------|--------------|
| | 7.1 m BER-boom | | 8.4 m R-boom |
| | 2.95 m BER-arm | 3.7 m R-arm | 3.7 m R-arm |
| A Max. digging reach | 12 340 | 12 820 | 14 100 |
| A' Max. digging reach (on ground) | 12 020 | 12 510 | 13 820 |
| B Max. digging depth | 7 140 | 7 820 | 8 870 |
| B' Max. digging depth (for 2.5 m level) | 7 000 | 7 690 | 8 740 |
| C Max. cutting height | 12 010 | 12 130 | 13 000 |
| D Max. dumping height | 8 130 | 8 180 | 9 080 |
| D' Min. dumping height | 3 770 | 3 000 | 3 990 |
| E Min. swing radius | 5 210 | 5 090 | 5 950 |
| F Max. vertical wall | 4 100 | 6 090 | 6 840 |

Excluding track shoe lug

LIFTING CAPACITIES (Without bucket)

Notes: 1. Ratings are based on ISO 10567.

2. Lifting capacity does not exceed 75% of tipping load with the machine on firm, level ground or 87% full hydraulic capacity.

3. The load point is the center-line of the bucket pivot mounting pin on the arm.

4. *Indicates load limited by hydraulic capacity.

5. 0 m = Ground.

For lifting capacities, subtract bucket and quick hitch weight from lifting capacities without bucket.

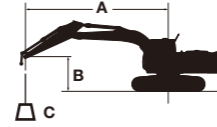

A: Load radius
B: Load point height
C: Lifting capacity

ZX870LCR-5G

⏪ Rating over-front ⏩ Rating over-side or 360 degrees Unit : kg

| Conditions | Load point height m | Load radius m | | | | | | | | | | | | At max. reach | | | | | |
|--|---------------------|---------------|---|---------|---------|---------|---------|---------|---------|---------|---------|---------|---------|---------------|---------|---------|---------|---------|--------|
| | | 1.5 | | 3.0 | | 4.5 | | 6.0 | | 7.5 | | 9.0 | | 10.5 | | | | | |
| | | ⏪ | ⏩ | ⏪ | ⏩ | ⏪ | ⏩ | ⏪ | ⏩ | ⏪ | ⏩ | ⏪ | ⏩ | ⏪ | ⏩ | | | | |
| BER-Boom 7.1 m BER-Arm 2.95 m Counterweight 13 300 kg Shoe 650 mm | 7.5 | | | | | | | | | *21 680 | *21 680 | | | *16 640 | *16 640 | 8.86 | | | |
| | 6.0 | | | | | | *26 800 | *26 800 | *23 090 | *23 090 | *21 100 | 18 210 | | *16 360 | *16 360 | 9.54 | | | |
| | 4.5 | | | | | | *30 910 | *30 910 | *25 130 | 23 420 | *21 960 | 17 730 | | *16 580 | 15 120 | 9.93 | | | |
| | 3.0 | | | | | | *34 610 | 30 980 | *27 150 | 22 420 | *22 950 | 17 180 | | *17 260 | 14 440 | 10.1 | | | |
| | 1.5 | | | | | | *36 640 | 29 720 | *28 540 | 21 610 | *23 640 | 16 700 | | *18 500 | 14 330 | 10.0 | | | |
| | 0 (Ground) | | | | | | *36 760 | 29 090 | *28 890 | 21 090 | *23 580 | 16 370 | | *20 540 | 14 800 | 9.70 | | | |
| | -1.5 | | | | | | | | *42 310 | *42 310 | *35 120 | 28 900 | *27 850 | 20 880 | *22 030 | 16 310 | 9.12 | | |
| | -3.0 | | | *41 860 | *41 860 | | | | *39 540 | *39 540 | *31 460 | 29 090 | *24 690 | 21 040 | | | *21 180 | 18 630 | 8.23 |
| -4.5 | | | | | *30 760 | *30 760 | | | *24 280 | *24 280 | | | | | *19 610 | *19 610 | 6.88 | | |
| BER-Boom 7.1 m R-Arm 3.7 m Counterweight 13 300 kg Shoe 650 mm | 7.5 | | | | | | | | | *19 460 | *19 460 | *14 830 | *14 830 | | | *10 770 | *10 770 | 9.47 | |
| | 6.0 | | | | | | | | | *21 600 | *21 600 | *19 070 | 18 730 | | | *10 750 | *10 750 | 10.1 | |
| | 4.5 | | | | | | | | | | | | | | | *11 030 | *11 030 | 10.5 | |
| | 3.0 | | | | | | *39 160 | *39 160 | | | | | | | | | | 10.6 | |
| | 1.5 | | | | | | *33 170 | 32 070 | *26 270 | 23 050 | *22 330 | 17 600 | *13 680 | *13 680 | *11 620 | *11 620 | 10.6 | | |
| | 0 (Ground) | | | | | | *36 110 | 30 560 | *28 140 | 22 140 | *23 390 | 17 040 | *13 650 | *13 590 | *12 590 | *12 590 | 10.6 | | |
| | -1.5 | | | | | | | | | | | | | | | | *14 110 | 13 830 | 10.3 |
| | -3.0 | | | | | | | | | | | | | | | | *16 600 | 14 780 | 9.72 |
| -4.5 | | | | | | | | *43 940 | *43 940 | *33 980 | 29 210 | *26 840 | 21 070 | | | *21 110 | 16 740 | 8.88 | |
| R-Boom 8.4 m R-Arm 3.7 m Counterweight 13 300 kg Shoe 650 mm | 9.0 | | | | | | | | | | | | | | | | | | |
| | 7.5 | | | | | | | | | | | | | | | | | | |
| | 6.0 | | | | | | | | | *24 800 | *24 800 | *20 480 | *20 480 | *16 160 | *16 160 | *12 170 | *12 170 | 10.1 | |
| | 4.5 | | | | | | | | | *29 480 | *29 480 | *22 990 | 22 510 | *19 460 | 17 210 | *17 310 | 13 620 | *12 500 | 11.8 |
| | 3.0 | | | | | | | | | *33 330 | 29 160 | *25 320 | 21 380 | *20 890 | 16 530 | *18 150 | 13 210 | *13 150 | 10.900 |
| | 1.5 | | | | | | | | | | | | | | | | | | |
| | 0 (Ground) | | | | | | | | | | | | | | | | | | |
| | -1.5 | | | | | | | | | | | | | | | | | | |
| | -3.0 | | | | | | | | | | | | | | | | | | |
| | -4.5 | | | | | | | | | | | | | | | | | | |
| -6.0 | | | | | | | | | | | | | | | | | | | |

TRANSPORTATION

ZX470R-5G / ZX470LCR-5G

BASIC MACHINE (WITHOUT COUNTERWEIGHT)

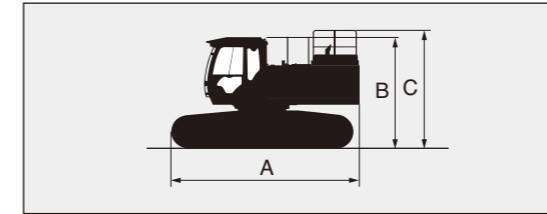

| | Shoe width | Overall width | Weight | A | B | C |
|-------------|------------|---------------|-----------|----------|----------|----------|
| ZX470R-5G | 600 mm | 3 340 mm | 27 100 kg | 5 470 mm | 3 320 mm | 3 540 mm |
| ZX470LCR-5G | | | 28 300 kg | 5 690 mm | 3 360 mm | 3 580 mm |

BASIC MACHINE FITTED WITH BOOM AND NO SIDEWALK

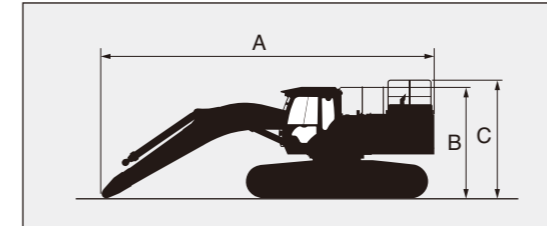

| | Boom length | Shoe width | Overall width | Weight | A | B | C |
|-------------|-------------|------------|---------------|-----------|----------|----------|----------|
| ZX470LCR-5G | 6.3 m BER | 600 mm | 3 340 mm | 33 700 kg | 9 160 mm | 3 360 mm | 3 580 mm |
| ZX470R-5G | | | | 32 500 kg | 9 950 mm | 3 320 mm | 3 540 mm |
| ZX470LCR-5G | 7.0 m R | | | 33 700 kg | 9 940 mm | 3 360 mm | 3 580 mm |

BASIC MACHINE WITH FRONT AND SIDEWALK

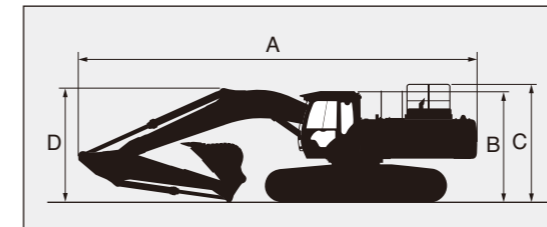

| Boom length | 6.3 m BER | | 7.0 m R | |
|-------------|---------------|---------------|--------------------|--------------------|
| Arm length | 2.5 m BER | 2.9 m BER | 2.9 m BER | 3.4 m R |
| A | - / 11 490 mm | - / 11 360 mm | 12 100 / 12 100 mm | 12 040 / 12 030 mm |
| B | - / 3 360 mm | | 3 320 / 3 360 mm | |
| C | - / 3 580 mm | | 3 540 / 3 580 mm | |
| D | - / 4 130 mm | - / 3 880 mm | 3 740 / 3 740 mm | |

ARM AND BUCKET

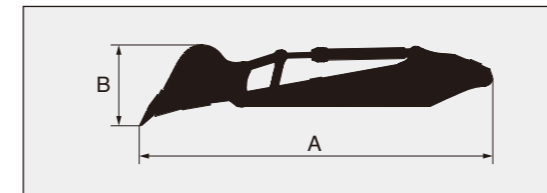

| Arm | Bucket ISO heaped | A | B | Overall width | Weight |
|-----------|---------------------|----------|----------|---------------|----------|
| 2.5 m BER | 2.50 m ³ | 5 650 mm | 1 470 mm | 1 820 mm | 5 590 kg |
| 2.9 m BER | 2.30 m ³ | 6 030 mm | 1 340 mm | 1 700 mm | 4 770 kg |
| 3.4 m R | 1.90 m ³ | 6 370 mm | 1 470 mm | 1 500 mm | 4 790 kg |

BUCKET

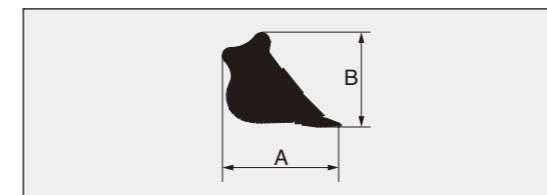

R-bucket

| Bucket ISO heaped | A | B | Overall width | Weight |
|---------------------|----------|----------|---------------|----------|
| 1.90 m ³ | 2 030 mm | 1 480 mm | 1 500 mm | 2 070 kg |
| 2.10 m ³ | 1 950 mm | 1 650 mm | 1 580 mm | 2 170 kg |
| 2.30 m ³ | 1 950 mm | 1 650 mm | 1 700 mm | 2 260 kg |
| 2.50 m ³ | 1 950 mm | 1 650 mm | 1 820 mm | 2 360 kg |

COUNTERWEIGHT 9 080 kg

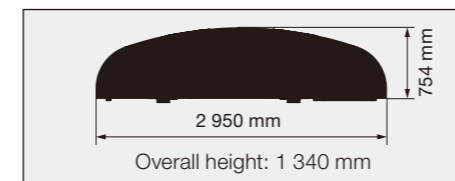

LEFT FRONT SIDEWALK 44 kg

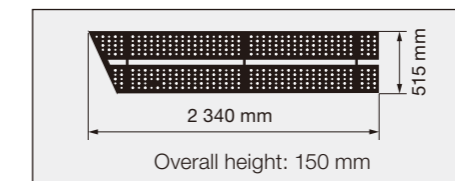

LEFT REAR SIDEWALK 30 kg

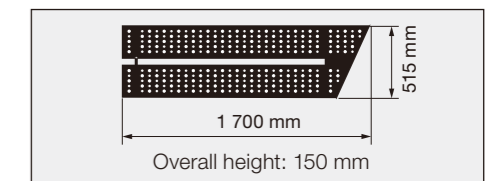

ZX670LCR-5G

UPPERSTRUCTURE

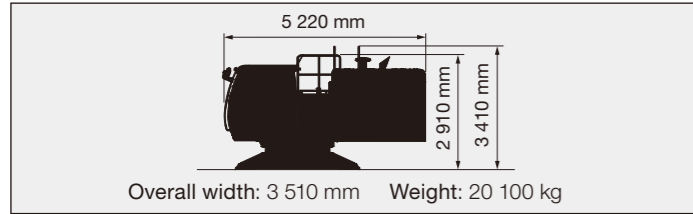

COUNTERWEIGHT

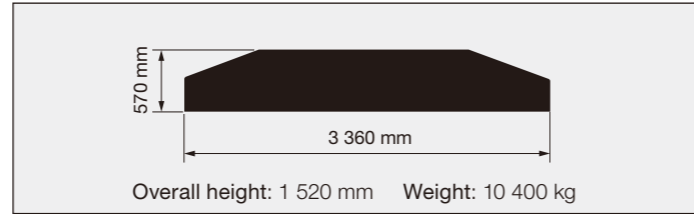

BASIC MACHINE (WITHOUT COUNTERWEIGHT)

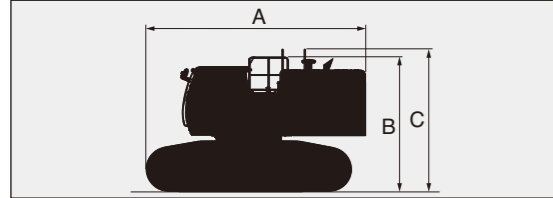

| Shoe width | Overall width ^{*1} | Weight | A | B | C |
|------------|-----------------------------|-----------|----------|----------|----------|
| 650 mm | 3 480 mm | 43 700 kg | 6 240 mm | 3 820 mm | 4 050 mm |

^{*1} Undercarriage retracted

SIDE FRAME

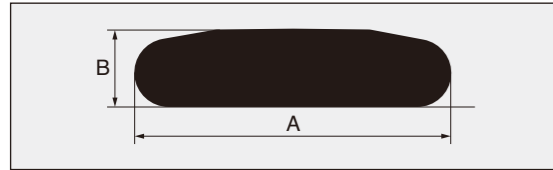

| Shoe width | Overall width | Weight | A | B |
|------------|---------------|-----------|----------|----------|
| 650 mm | 1 250 mm | 10 800 kg | 5 840 mm | 1 450 mm |

BOOM

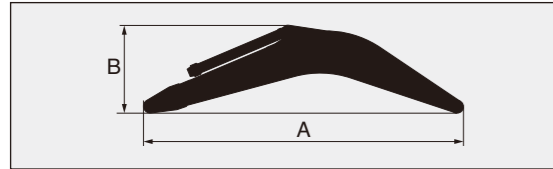

| Boom | A | B | Overall width | Weight |
|-----------|----------|----------|---------------|----------|
| 6.8 m BER | 7 140 mm | 2 510 mm | 1 390 mm | 6 260 kg |
| 7.8 m R | 8 130 mm | 2 330 mm | 1 390 mm | 6 760 kg |

ARM



| Arm | A | B | Overall width | Weight |
|-----------|----------|----------|---------------|----------|
| 2.9 m BER | 4 370 mm | 1 690 mm | 800 mm | 3 950 kg |
| 3.6 m R | 5 110 mm | 1 440 mm | 800 mm | 3 900 kg |

BUCKET

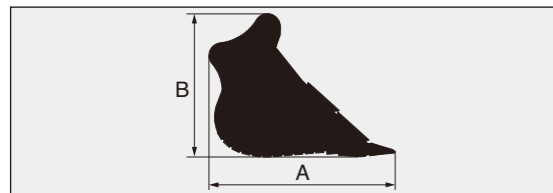

R-bucket

| Bucket Capacity ISO heaped | A | B | Overall width | Weight |
|----------------------------|----------|----------|---------------|----------|
| 2.90 m ³ | 2 290 mm | 1 770 mm | 1 680 mm | 3 300 kg |
| 3.30 m ³ | 2 250 mm | 1 890 mm | 1 790 mm | 3 610 kg |

BOOM CYLINDERS 550 kg X 2 Overall height: 410 mm

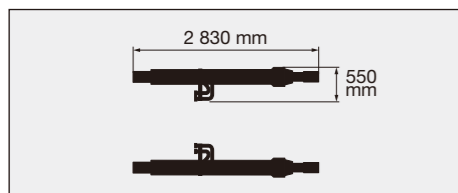

HOSE OF BOOM CYLINDERS 7 kg X 2 / 10 kg X 2

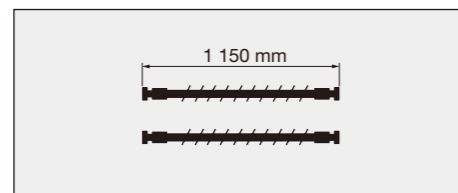

LEFT SIDEWALK Overall height: 150 mm

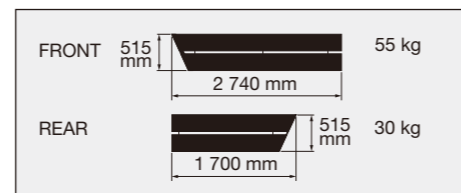

ZX870LCR-5G

UPPERSTRUCTURE

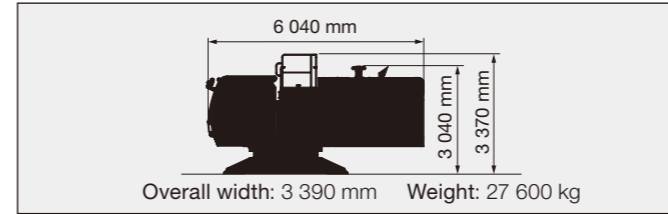

COUNTERWEIGHT

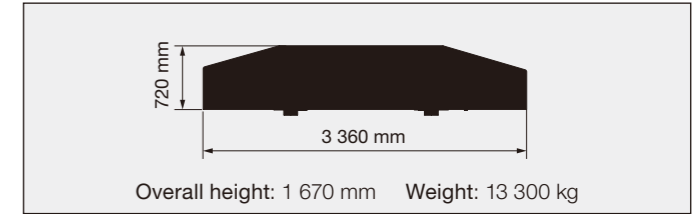

BASIC MACHINE (WITHOUT COUNTERWEIGHT)

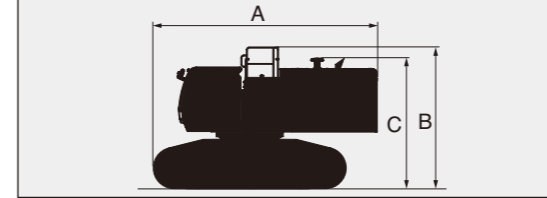

| Shoe width | Overall width ^{*1} | Weight | A | B | C |
|------------|-----------------------------|-----------|----------|----------|----------|
| 650 mm | 3 600 mm | 52 600 kg | 7 080 mm | 4 300 mm | 3 960 mm |

^{*1} Undercarriage retracted

SIDE FRAME

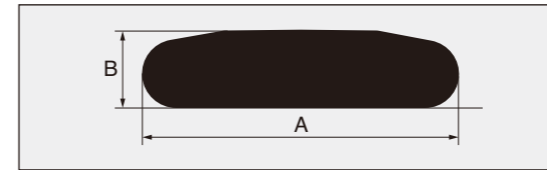

| Shoe width | Overall width | Weight | A | B |
|------------|---------------|-----------|----------|----------|
| 650 mm | 1 330 mm | 12 700 kg | 6 360 mm | 1 500 mm |

BOOM

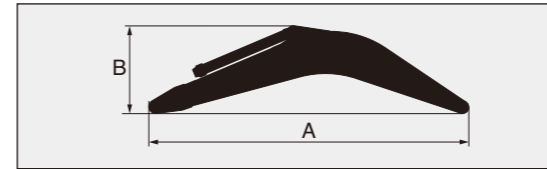

| Boom | A | B | Overall width | Weight |
|-----------|----------|----------|---------------|----------|
| 7.1 m BER | 7 490 mm | 2 700 mm | 1 450 mm | 7 680 kg |
| 8.4 m R | 8 780 mm | 2 500 mm | 1 450 mm | 8 270 kg |

ARM

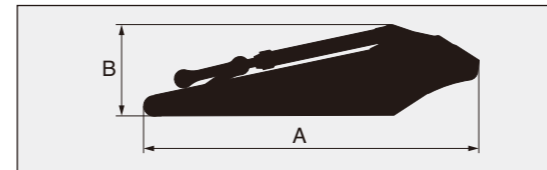

| Arm | A | B | Overall width | Weight |
|------------|----------|----------|---------------|----------|
| 2.95 m BER | 4 460 mm | 1 660 mm | 850 mm | 4 760 kg |
| 3.7 m R | 5 290 mm | 1 420 mm | 820 mm | 4 610 kg |

BUCKET

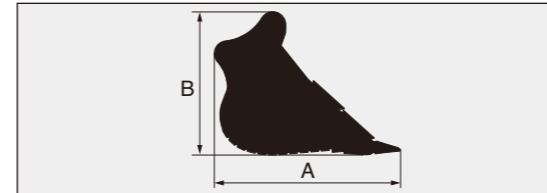

R-bucket

| Bucket Capacity ISO heaped | A | B | Overall width | Weight |
|----------------------------|----------|----------|---------------|----------|
| 3.50 m ³ | 2 240 mm | 1 920 mm | 1 890 mm | 4 870 kg |
| 3.70 m ³ | 2 240 mm | 1 920 mm | 1 970 mm | 4 970 kg |
| 4.30 m ³ | 2 310 mm | 2 000 mm | 2 110 mm | 5 690 kg |

BOOM CYLINDERS 850 kg X 2 Overall height: 410 mm

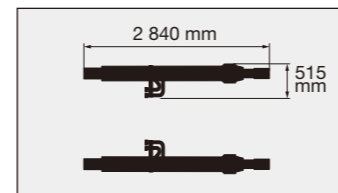

HOSE OF BOOM CYLINDERS 9 kg X 2 / 13 kg X 2

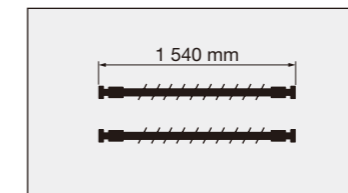

LEFT SIDEWALK Overall height: 150 mm

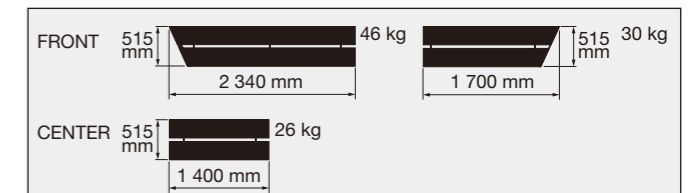

EQUIPMENT

Standard and optional equipment may vary by country, so please consult your Hitachi dealer for details.

● : Standard equipment ○ : Optional equipment — : Not applicable

| ENGINE | ZX470R-5G | ZX470LCR-5G | ZX670LCR-5G | ZX870LCR-5G |
|--|-----------|-------------|-------------|-------------|
| Auto idle system | ● | ● | ● | ● |
| Cartridge-type engine oil filter | ● | ● | ● | ● |
| Cartridge-type fuel filter | ● | ● | ● | ● |
| Dry-type air double filter with evacuator valve (with air filter restriction switch for monitor) | ● | ● | ● | ● |
| Fan guard | ● | ● | ● | ● |
| Fuel pre-filter | ● | ● | ● | ● |
| Power mood control [H/P (High Power) PWR(Power) ECO(Economy)] | ● | ● | ● | ● |
| Isolation-mounted engine | ● | ● | ● | ● |
| Pre-cleaner | ○ | ○ | ○ | ○ |
| Radiator, oil cooler with dust protective net | ● | ● | ● | ● |
| Radiator reserve tank | ● | ● | ● | ● |
| 50 A alternator | ● | ● | ● | ● |

| HYDRAULIC SYSTEM | | | | |
|--|---|---|---|---|
| Accessories for breaker | ○ | ○ | ○ | ○ |
| Accessories for breaker & crusher | ○ | ○ | ○ | ○ |
| Accessories for 2 speed selector | ○ | ○ | ○ | ○ |
| Auto power lift | ● | ● | ● | ● |
| Boom mode selector system | ● | ● | ● | ● |
| Control valve with main relief valve | ● | ● | ● | ● |
| Drain filter | ● | ● | ● | ● |
| Engine speed sensing system | ● | ● | ● | ● |
| E-P control system | ● | ● | ● | ● |
| Extra port for control valve | ● | ● | ● | ● |
| Full-flow filter | ● | ● | ● | ● |
| Hose rupture valve | ○ | ○ | ○ | ○ |
| Pilot filter | ● | ● | ● | ● |
| Power boost | ● | ● | ● | ● |
| Quick warm-up system for pilot circuit | ● | ● | ● | ● |
| Shockless valve in pilot circuit | ● | ● | ● | ● |
| Suction filter | ● | ● | ● | ● |
| Work mode selector | ● | ● | ● | ● |

| CAB | | | | |
|--|---|---|---|---|
| Additional fuse box | ● | ● | ● | ● |
| Adjustable armrests | ● | ● | ● | ● |
| All-weather sound suppressed steel cab | ● | ● | ● | ● |
| AM-FM radio | ● | ● | ● | ● |
| Ashtray | ● | ● | ● | ● |
| Auto control air conditioner | ● | ● | ● | ● |
| Auto-idle selector | ● | ● | ● | ● |
| AUX. terminal and storage | ○ | ○ | ○ | ○ |
| Cab: H/R cab | ● | ● | ● | ● |
| OPG top guard fitted Level II (ISO10262) | ● | ● | ● | ● |
| OPG front guard fitted Level II (ISO10262) | ○ | ○ | ○ | ○ |
| Laminated straight glass front window | ● | ● | ● | ● |

| | ZX470R-5G | ZX470LCR-5G | ZX670LCR-5G | ZX870LCR-5G |
|---|-----------|-------------|-------------|-------------|
| Drink holder | ● | ● | ● | ● |
| Engine shut-off cable | ● | ● | ● | ● |
| Electric double horn | ● | ● | ● | ● |
| Evacuation hammer | ● | ● | ● | ● |
| Fire extinguisher bracket | ○ | ○ | ○ | ○ |
| Floor mat | ● | ● | ● | ● |
| Footrest | ● | ● | ● | ● |
| Front window washer | ● | ● | ● | ● |
| Glove compartment | ● | ● | ● | ● |
| Hot & cool box | ● | ● | ● | ● |
| Intermittent windshield wiper | ● | ● | ● | ● |
| Key cylinder light | ● | ● | ● | ● |
| LED room light with door courtesy | ● | ● | ● | ● |
| Left side window can be opened | ● | ● | ● | ● |
| Pilot control shut-off lever | ● | ● | ● | ● |
| Rear tray | ● | ● | ● | ● |
| Retractable seat belt | ● | ● | ● | ● |
| Rubber radio antenna | ● | ● | ● | ● |
| Seat : Adjustable reclining mechanical suspension | ● | ● | ● | ● |
| Seat : Adjustable reclining mechanical suspension with heater | ○ | ○ | ○ | ○ |
| Seat : Adjustable reclining air suspension with heater | ○ | ○ | ○ | ○ |
| Short wrist control levers | ● | ● | ● | ● |
| Storage box | ● | ● | ● | ● |
| Sun visor (front) | ○ | ○ | ○ | ○ |
| Sun visor (side) | ○ | ○ | ○ | ○ |
| Transparent roof with slide curtain | ● | ● | ● | ● |
| 2 speakers | ● | ● | ● | ● |
| 6 fluid-filled elastic mounts | ● | ● | ● | ● |
| 12 V power outlet | ○ | ○ | ○ | ○ |
| 24 V cigarette lighter | ● | ● | ● | ● |

| MONITOR SYSTEM | | | | |
|--|---|---|---|---|
| Alarm buzzers: overheat, engine oil pressure | ● | ● | ● | ● |
| Alarms: overheat, engine warning, engine oil pressure, alternator, minimum fuel level, air filter restriction, work mode, etc. | ● | ● | ● | ● |
| Display of meters: water temperature, hour, fuel rate, clock | ● | ● | ● | ● |
| Other displays: work mode, auto-idle, glow, operating conditions etc. | ● | ● | ● | ● |

| LIGHTS | | | | |
|--|---|---|---|---|
| Additional working light (boom light side) | ○ | ○ | ○ | — |
| 2 cab lights | ● | ● | ● | ● |
| 2 working lights | ● | ● | — | — |
| 3 working lights | — | — | ● | — |
| 4 cab lights | ○ | ○ | ○ | ○ |
| 4 working lights | — | — | — | ● |

Standard and optional equipment may vary by country, so please consult your Hitachi dealer for details.

● : Standard equipment ○ : Optional equipment — : Not applicable

| UPPER STRUCTURE | ZX470R-5G | ZX470LCR-5G | ZX670LCR-5G | ZX870LCR-5G |
|---|-----------|-------------|-------------|-------------|
| Auto-grease lubricator (without bucket and link pins) | ○ | ○ | ○ | ○ |
| Electric fuel refilling pump with auto stop | ○ | ○ | ○ | ○ |
| Electrical grease pump with hose-reel | ○ | ○ | ○ | ○ |
| Fuel level float | ● | ● | ● | ● |
| Hydraulic oil level gauge | ● | ● | ● | ● |
| Ladder | ● | ● | ● | ● |
| Rear view camera | ○ | ○ | ○ | ○ |
| Rear view mirror (right & left side) | ● | ● | ● | ● |
| Side walk (cab side) | ● | ● | ● | ● |
| Swing parking brake | ● | ● | ● | ● |
| Tool box | ● | ● | ● | ● |
| Utility space | ● | ● | ● | ● |
| 170 Ah batteries | ● | ● | ● | ● |
| 4.5 mm thickness undercover | ● | ● | ● | ● |
| 9 080 kg counterweight | ● | ● | — | — |
| 10 400 kg counterweight | — | — | ● | — |
| 13 300 kg counterweight | — | — | — | ● |

| UNDERCARRIAGE | | | | |
|---------------------------------------|---|---|---|---|
| Bolt-on sprocket | ● | ● | ● | ● |
| Full track guard | ● | ● | ● | ● |
| Hydraulic track adjuster | ● | ● | ● | ● |
| Reinforced track links with pin seals | ● | ● | ● | ● |
| Reinforced idler part | ● | ● | ● | ● |
| Reinforced travel motor covers | ● | ● | ● | ● |
| Travel parking brake | ● | ● | ● | ● |
| Track undercover | ○ | ○ | ○ | ○ |
| Upper and lower rollers | ● | ● | ● | ● |
| 600 mm triple grouser shoes | ● | ● | — | — |
| 600 mm double grouser shoes | ○ | ○ | — | — |
| 650 mm double grouser shoes | — | — | ● | ● |

| FRONT ATTACHMENTS | ZX470R-5G | ZX470LCR-5G | ZX670LCR-5G | ZX870LCR-5G |
|--|-----------|-------------|-------------|-------------|
| Arm cylinder hose protectors | ● | ● | ● | ● |
| Boom cylinder hose protectors | ● | ● | ● | ● |
| Bucket cylinder hose protectors | ● | ● | ● | ● |
| Centralized lubrication system | ● | ● | ● | ● |
| Damage prevention plate and square bars | ● | ● | ● | ● |
| Dirt seal on all bucket pins | ● | ● | ● | ● |
| Flanged pin | ● | ● | ● | ● |
| Reinforced link A | ● | ● | ● | ● |
| Reinforced link B | ● | ● | ● | ● |
| 1.9 m ³ (ISO heaped) R-bucket (with dual type side shrouds) | ● | ● | — | — |
| 7.0 m R-boom and 3.4 m R-arm | ● | ● | — | — |
| 6.3 m BER-boom | ○ | ○ | — | — |
| 2.5 m BER-arm | ○ | ○ | — | — |
| 2.9 m BER-arm | ○ | ○ | — | — |
| 2.9 m ³ (ISO heaped) R-bucket (with dual type side shrouds) | — | — | ● | — |
| 7.8 m R-boom and 3.6 m R-arm | — | — | ● | — |
| 6.8 m BER-boom | — | — | ○ | — |
| 2.9 m BER-arm | — | — | ○ | — |
| 3.5 m ³ (ISO heaped) R-bucket (with dual type side shrouds) | — | — | — | ● |
| 8.4 m R-boom and 3.7 m R-arm | — | — | — | ● |
| 7.1 m BER-boom | — | — | — | ○ |
| 2.95 m BER-arm | — | — | — | ○ |

| MISCELLANEOUS | | | | |
|--------------------------------------|---|---|---|---|
| Anti-slip steps and handrails | ● | ● | ● | ● |
| Lockable fuel refilling cap | ● | ● | ● | ● |
| Lockable machine covers | ● | ● | ● | ● |
| Onboard information controller | ● | ● | ● | ● |
| Standard tool kit | ● | ● | ● | ● |
| Theft deterrent system | ● | ● | ● | ● |
| Travel direction mark on track frame | ● | ● | ● | ● |

| OTHERS | | | | |
|------------------|---|---|---|---|
| Global e-Service | ● | ● | ● | ● |



Built on the foundation of superb technological capabilities, Hitachi Construction Machinery is committed to providing leading-edge solutions and services to contribute as a reliable partner to the business of customers worldwide.

Hitachi Environmental Vision 2025

The Hitachi Group released the Environmental Vision 2025 to curb annual carbon dioxide emissions. The Group is committed to global production while reducing environmental impact in life cycles of all products, and realizing a sustainable society by tackling three goals — prevention of global warming, conservation of resources, and preservation of ecosystem.

Reducing Environmental Impact by New ZAXIS

Hitachi makes a green way to cut carbon emissions for global warming prevention according to LCA*. New ZAXIS utilizes lots of technological advances, including the new ECO mode, and Isochronous Control. Hitachi has long been committed to recycling of components, such as aluminum parts in radiators and oil cooler. Resin parts are marked for recycling.

*Life Cycle Assessment – ISO 14040

Before using a machine with a satellite communication system, please make sure that the satellite communication system complies with local regulations, safety standards and legal requirements. If not so, please make modifications accordingly.

These specifications are subject to change without notice. Illustrations and photos show the standard models, and may or may not include optional equipment, accessories, and all standard equipment with some differences in color and features. Before use, read and understand the Operator's Manual for proper operation.